



**PREFEITURA DE**  
**HORIZONTE**  
DE MÃOS DADAS COM VOCÊ



**ANEXO III – PROJETO ARQUITETÔNICO-SECRETARIA DE SAÚDE  
(CENTRO DE IMAGENS)**



*(Handwritten signature)*



# CENTRO DE IMAGENS

---

## CADERNO DE DETALHAMENTO DE MARCENARIA

OUTUBRO DE 2023



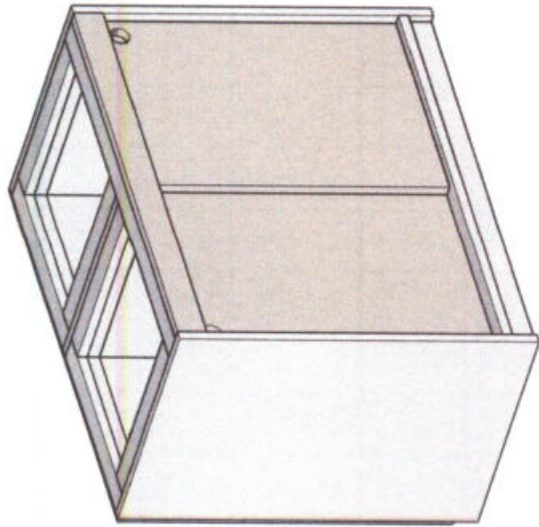

01 - ISOMÉTRICA MB1  
ESCALA.....1/10

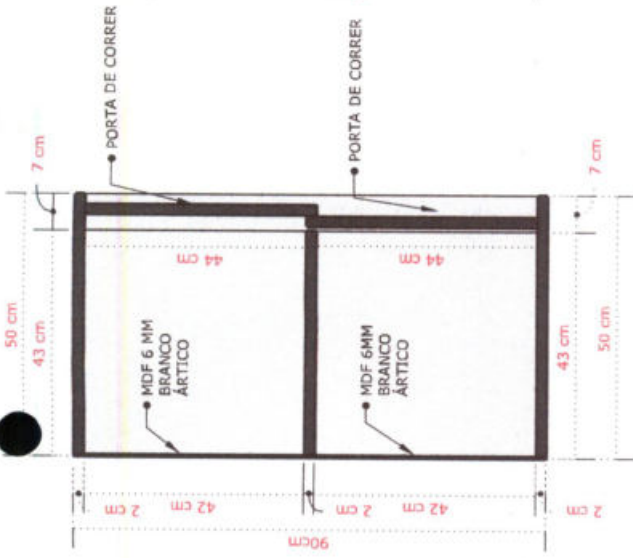

02 - PLANTA BAIXA MB1  
ESCALA.....1/10

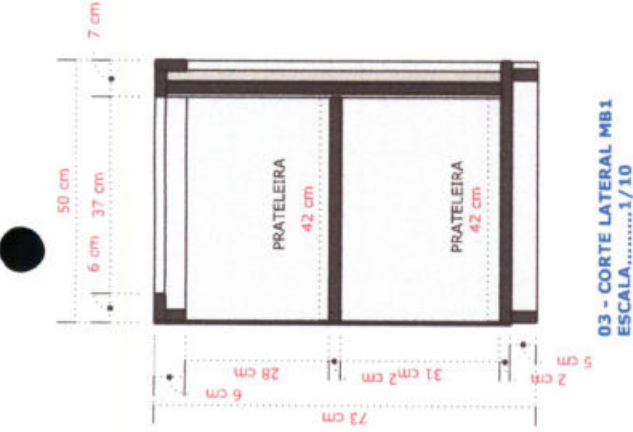

03 - CORTE LATERAL MB1  
ESCALA.....1/10

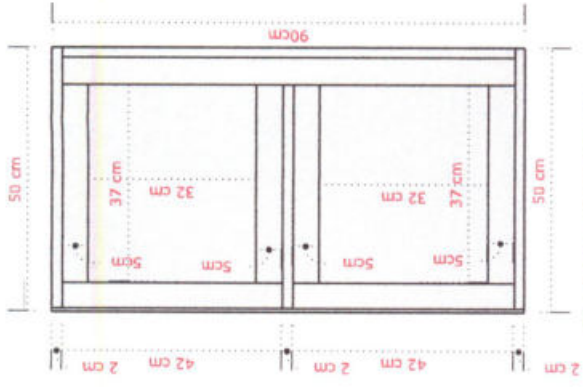

04 - VISTA SUPERIOR MB1  
ESCALA.....1/10

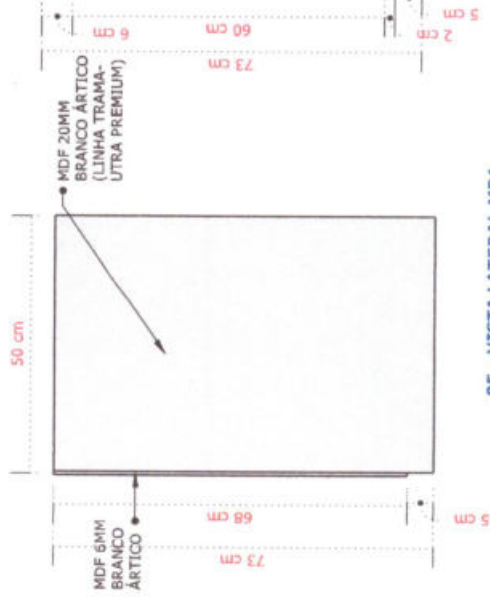

05 - VISTA LATERAL MB1  
ESCALA.....1/10

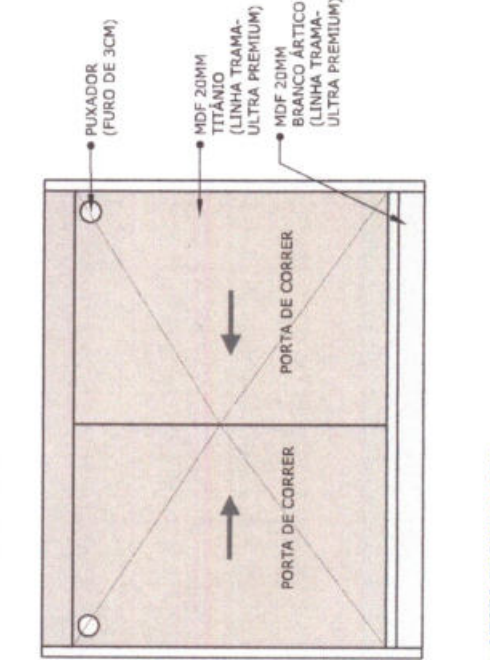

06 - VISTA FRONTAL MB1  
ESCALA.....1/10

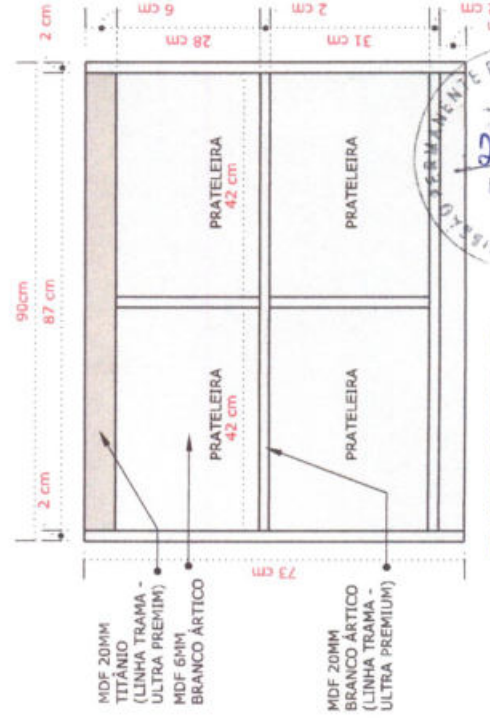

07 - VISTA INTERNA MB1  
ESCALA.....1/10



ATENÇÃO: CONFERIR MEDIDAS DOS AMBIENTES ANTES DE EXECUTAR OS MÓVEIS

**MOBILIÁRIO CENTRO DE IMAGENS DE HORIZONTE**

- CONTEÚDO:
- 01- ISOMÉTRICA MB1.....1/10
  - 02- PLANTA BAIXA MB1.....1/10
  - 03- CORTE LATERAL MB1.....1/10
  - 04- VISTA SUPERIOR MB1.....1/10
  - 05- VISTA LATERAL MB1.....1/10
  - 06- VISTA FRONTAL MB1.....1/10
  - 07- VISTA INTERNA MB1.....1/10

PRANCHA:

01/65

LOCAL: HORIZONTE - CE

AUTOR DO PROJETO: ARQ. GEFERSON RAFAEL- CAU Nº A261764-1

DATA: OUTUBRO - 2023





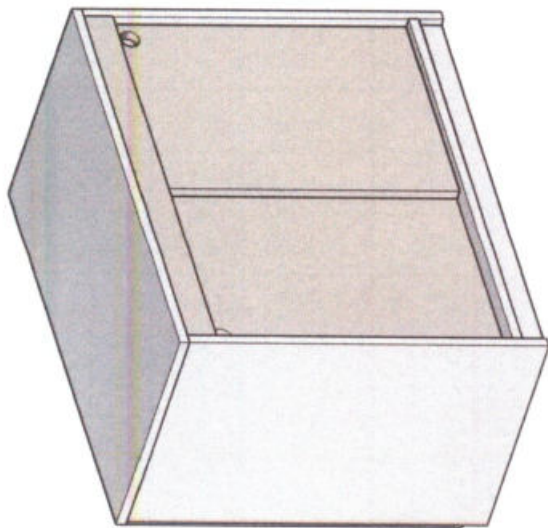

01 - ISOMÉTRICA MB2  
ESCALA.....1/10

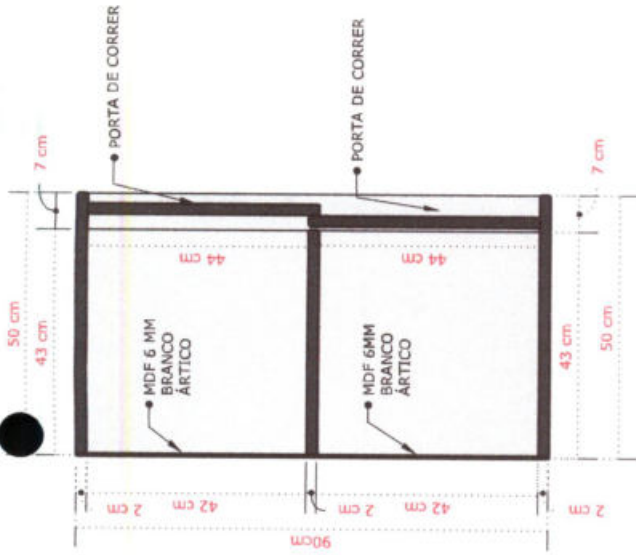

02 - PLANTA BAIXA MB2  
ESCALA.....1/10

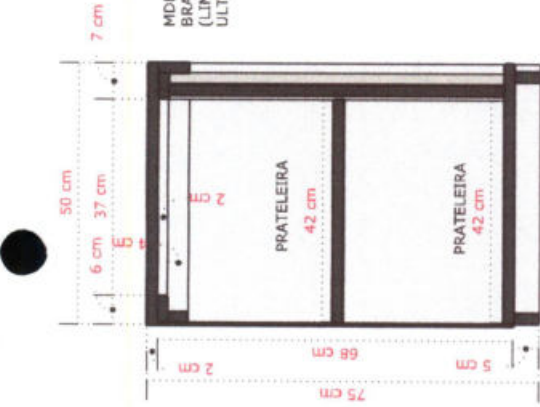

03 - CORTE LATERAL MB2  
ESCALA.....1/10

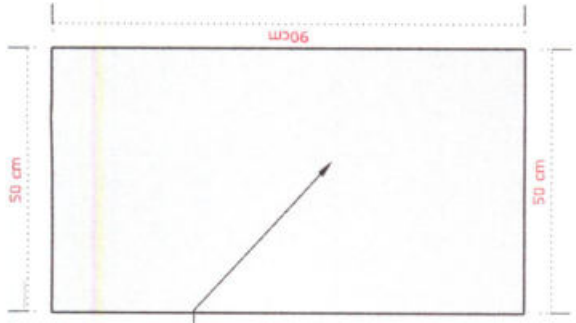

04 - VISTA SUPERIOR MB2  
ESCALA.....1/10

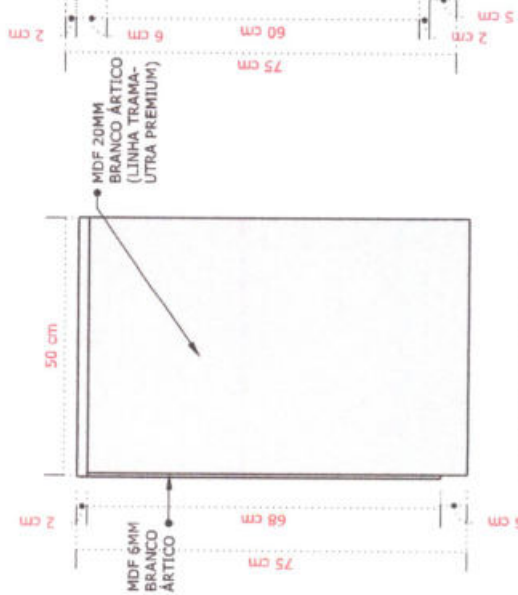

05 - VISTA LATERAL MB2  
ESCALA.....1/10

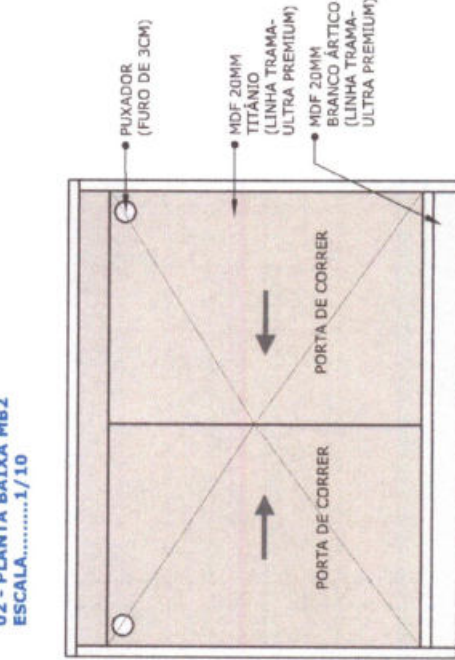

06 - VISTA FRONTAL MB2  
ESCALA.....1/10

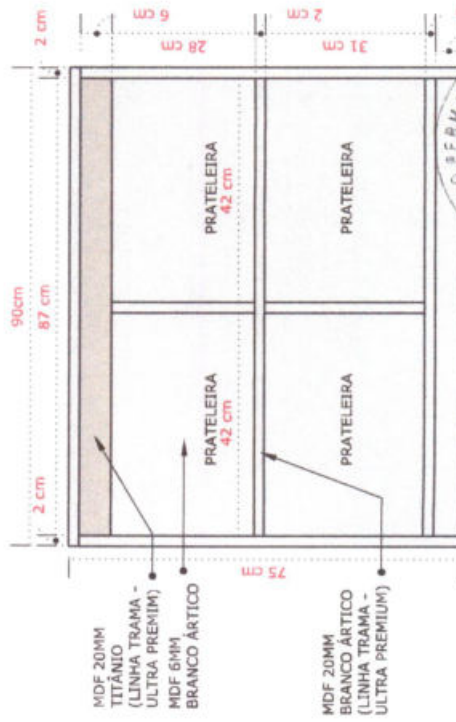

07 - VISTA INTERNA MB2  
ESCALA.....1/10

ATENÇÃO: CONFERIR MEDIDAS DOS AMBIENTES ANTES DE EXECUTAR OS MÓVEIS

**MOBILIÁRIO CENTRO DE IMAGENS DE HORIZONTE**

PROPRIETÁRIO: PREFEITURA MUNICIPAL DE HORIZONTE  
AUTOR DO PROJETO: ARQ. GEFERSON RAFAEL- CAU Nº A261764-1

LOCAL: HORIZONTE - CE  
DATA: OUTUBRO - 2023

- CONTEÚDO:
- 01- ISOMÉTRICA MB2.....1/10
  - 02- PLANTA BAIXA MB2.....1/10
  - 03- CORTE LATERAL MB2.....1/10
  - 04- VISTA SUPERIOR MB2.....1/10
  - 05- VISTA LATERAL MB2.....1/10
  - 06- VISTA FRONTAL MB2.....1/10
  - 07- VISTA INTERNA MB2.....1/10

PRANCHA:

02/65



*(Handwritten signature)*



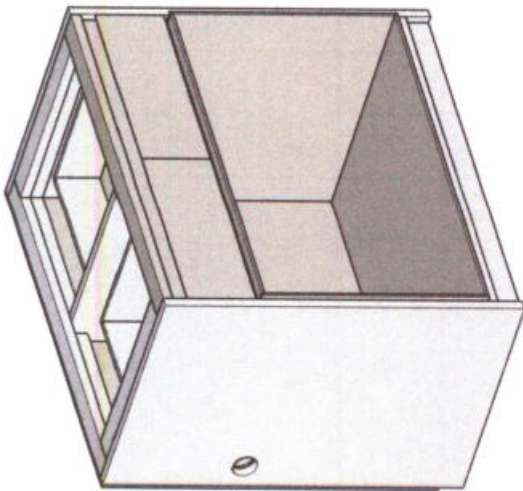

01 - ISOMÉTRICA MB3  
ESCALA.....1/10

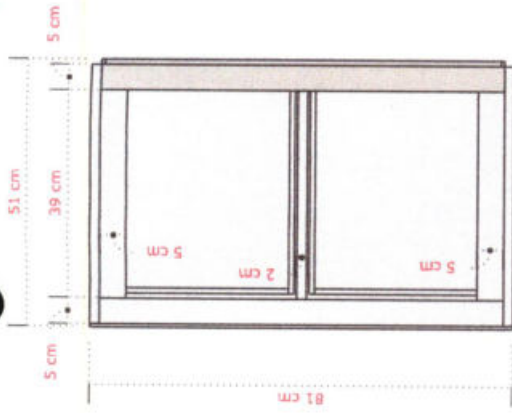

02 - VISTA SUPERIOR MB3  
ESCALA.....1/10

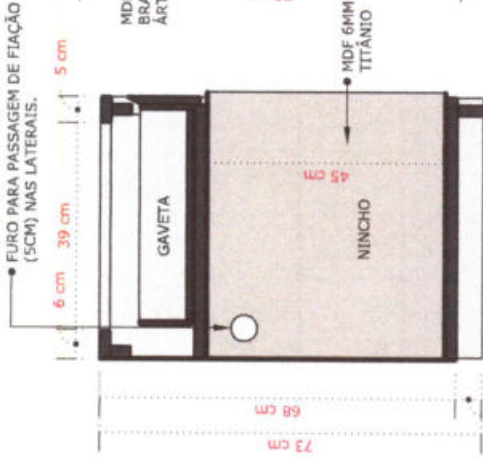

03 - CORTE LATERAL MB3  
ESCALA.....1/10

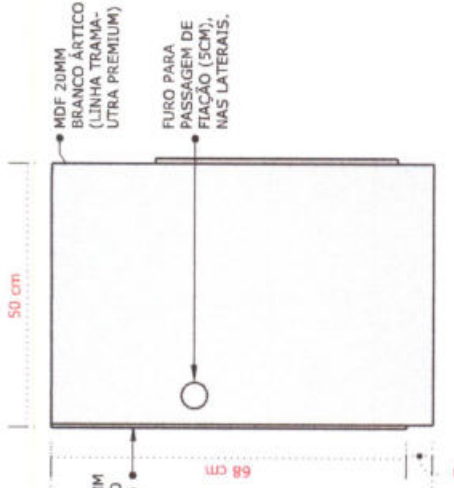

04 - VISTA LATERAL MB3  
ESCALA.....1/10

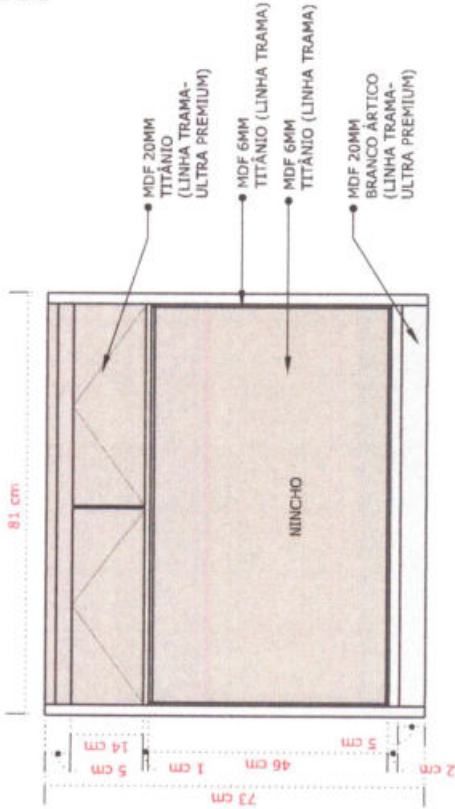

05 - VISTA FRONTAL MB3  
ESCALA.....1/10

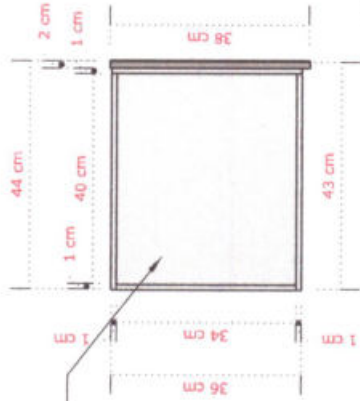

06 - DET. GAVETA MB3- VS  
ESCALA.....1/10

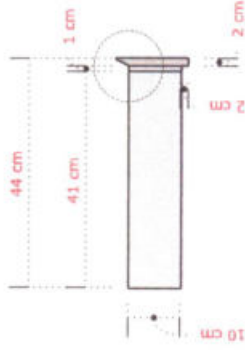

07 - DET. GAVETA MB3- VL  
ESCALA.....1/10

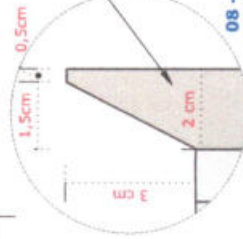

08 - DET. PUXADOR CAVA GAVETA MB3 SEM ESCALA



ATENÇÃO: CONFERIR MEDIDAS DOS AMBIENTES ANTES DE EXECUTAR OS MÓVEIS

- CONTEÚDO:
- 01- ISOMÉTRICA MB3.....1/10
  - 02- VISTA SUPERIOR MB3.....1/10
  - 03- CORTE LATERAL MB3.....1/10
  - 04- VISTA LATERAL MB3.....1/10
  - 05- VISTA FRONTAL MB3.....1/10
  - 06- DET. GAVETA MB3-VS.....1/10
  - 07- DET. GAVETA MB3-VL.....1/10
  - 08- DET. PUXADOR CAVA MB3...1/10

**MOBILIÁRIO CENTRO DE IMAGENS DE HORIZONTE**

PROPRIETÁRIO: PREFEITURA MUNICIPAL DE HORIZONTE

AUTOR DO PROJETO: ARQ. GEFERSON RAFAEL- CAU Nº A261764-1

LOCAL: HORIZONTE - CE

DATA: OUTUBRO - 2023



PRANCHA:  
**03/65**

*(Handwritten signature)*

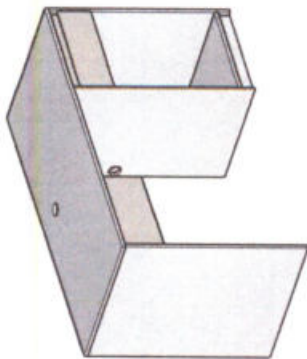

01 - ISOMÉTRICA MB4  
ESCALA.....1/10

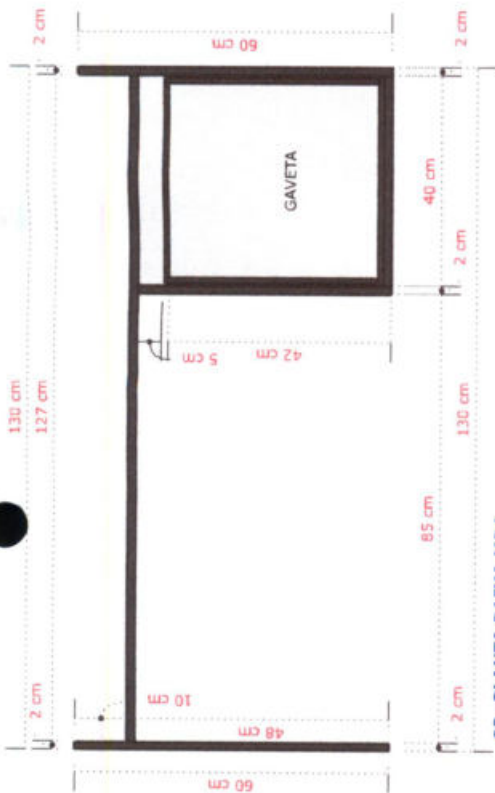

02- PLANTA BAIXA MB4  
ESCALA.....1/10

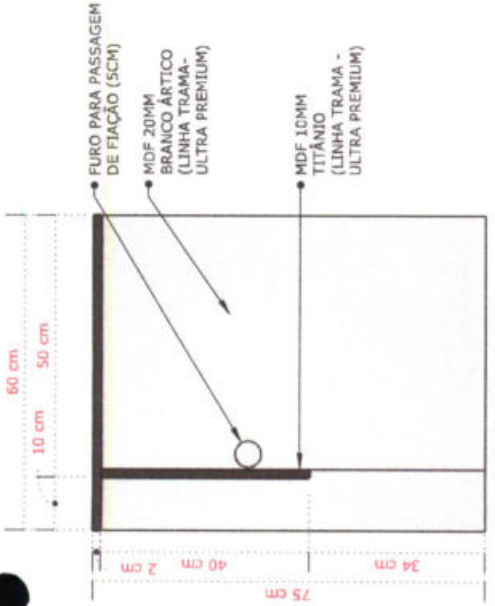

03- CORTE LATERAL MB4  
ESCALA.....1/10

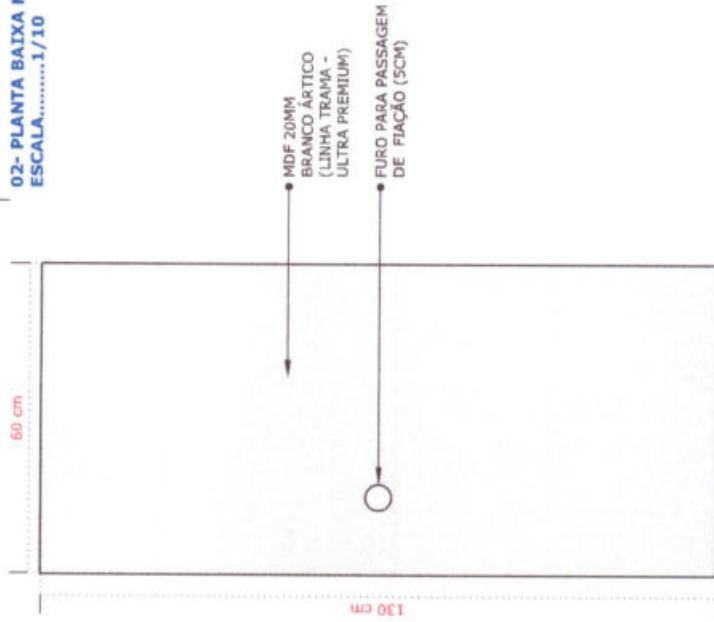

04- VISTA SUPERIOR MB4  
ESCALA.....1/10

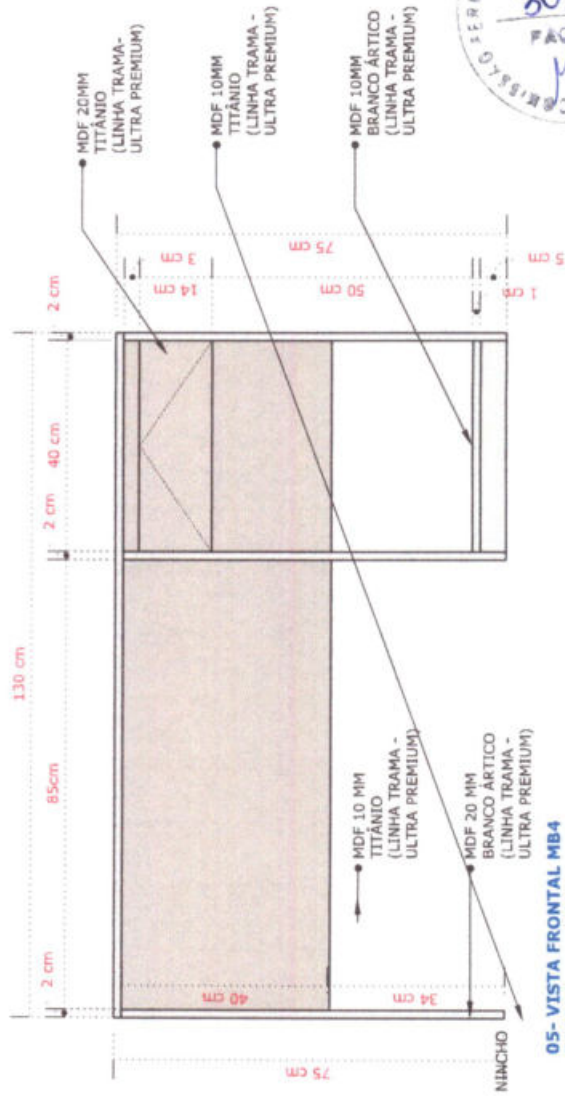

05- VISTA FRONTAL MB4  
ESCALA.....1/10



ATENÇÃO: CONFERIR MEDIDAS DOS AMBIENTES ANTES DE EXECUTAR OS MÓVEIS

**MOBILIÁRIO CENTRO DE IMAGENS DE HORIZONTE**

PROPRIETÁRIO: PREFEITURA MUNICIPAL DE HORIZONTE

LOCAL: HORIZONTE - CE

AUTOR DO PROJETO: ARQ. GEFERSON RAFAEL- CAU Nº A261764-1

DATA: OUTUBRO - 2023

**CONTEÚDO:**

- 01- ISOMÉTRICA MB4.....1/10
- 02- PLANTA BAIXA MB4 .....1/10
- 03- CORTE LATERAL MB4.....1/10
- 04- VISTA SUPERIOR MB4.....1/10
- 05- VISTA FRONTAL MB4.....1/10

**PRANCHA:**

**04/65**



*(Handwritten signature)*



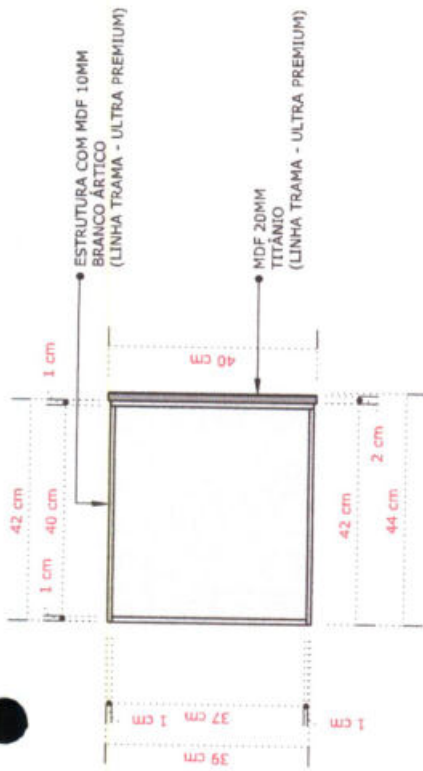

02 - DET. GAVETA VS MB4  
ESCALA.....1/20

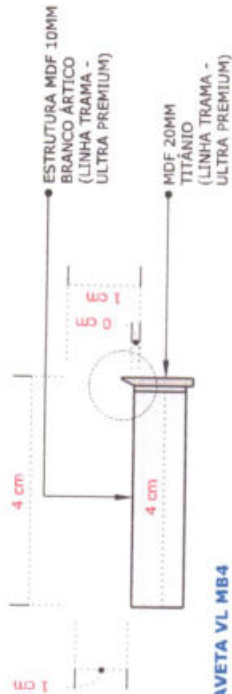

03 - DET. GAVETA VL MB4  
ESCALA.....1/20

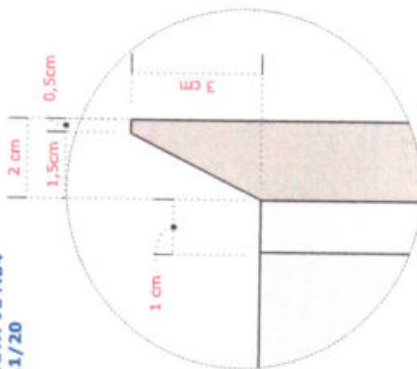

04 - DET. PUXADOR CAVA MB4  
ESCALA.....1/20

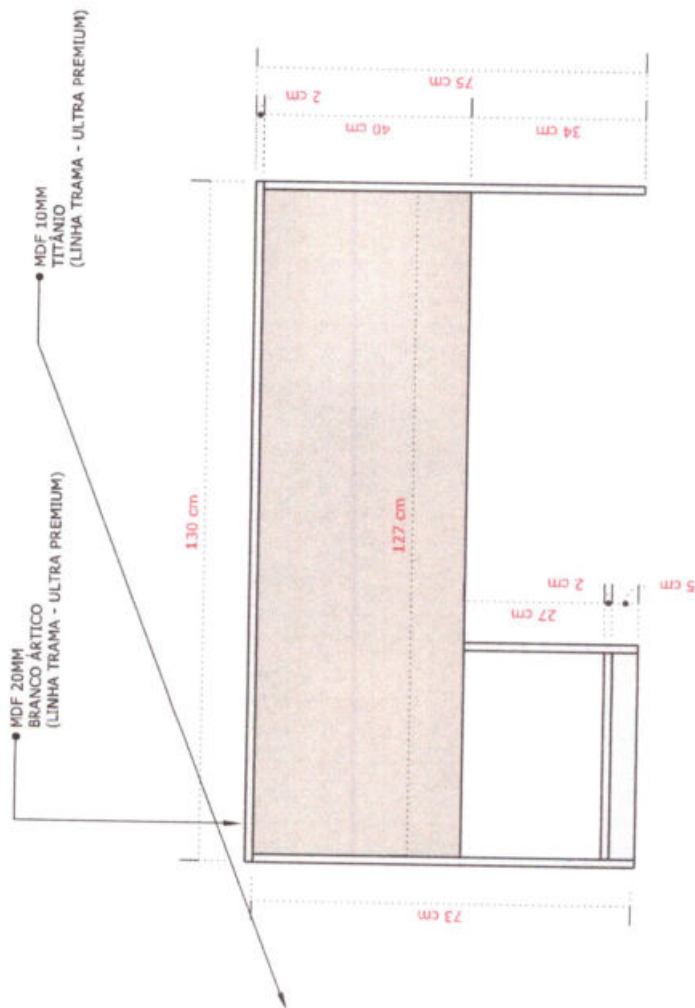

01 - VISTA POSTERIOR  
ESCALA.....1/20

ATENÇÃO: CONFERIR MEDIDAS DOS AMBIENTES ANTES DE EXECUTAR OS MÓVEIS



**MOBILIÁRIO CENTRO DE IMAGENS DE HORIZONTE**

PROPRIETÁRIO: PREFEITURA MUNICIPAL DE HORIZONTE  
 AUTOR DO PROJETO: ARQ. GEFERSON RAFAEL- CAU Nº A261764-1

LOCAL: HORIZONTE - CE  
 DATA: OUTUBRO - 2023

**CONTEÚDO:**

- 01- VISTA POSTERIOR.....1/20
- 02- DET. GAVETA VS MB4.....1/20
- 03- DET. GAVETA VL MB4.....1/20
- 04- DET. PUXADOR CAVA MB4...1/20

PRANCHA:

**05/65**



*(Handwritten signature)*

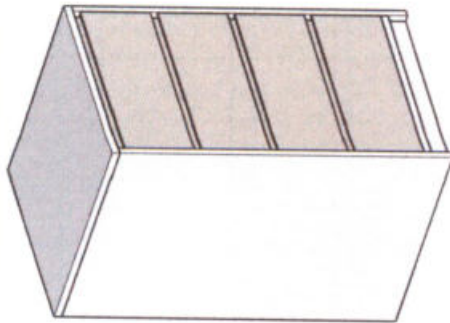

01 - ISOMÉTRICA MBS  
ESCALA.....1/10

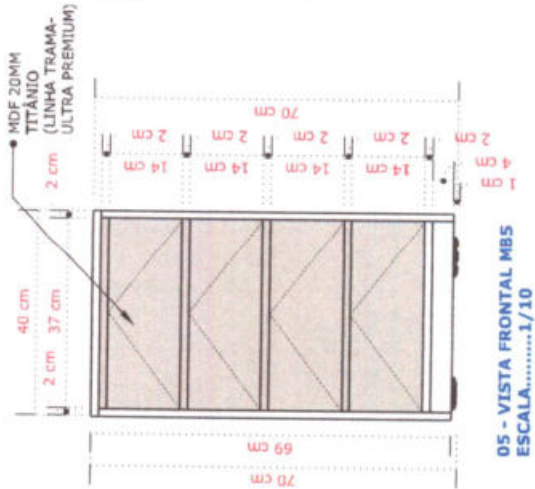

05 - VISTA FRONTAL MBS  
ESCALA.....1/10

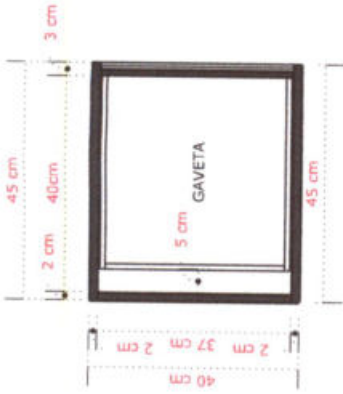

02 - PLANTA BAIXA MBS  
ESCALA.....1/10

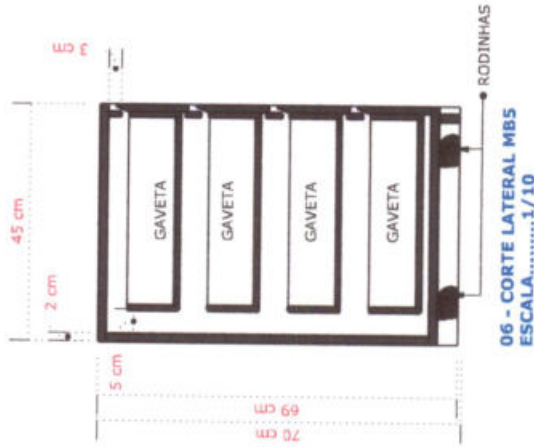

06 - CORTE LATERAL MBS  
ESCALA.....1/10

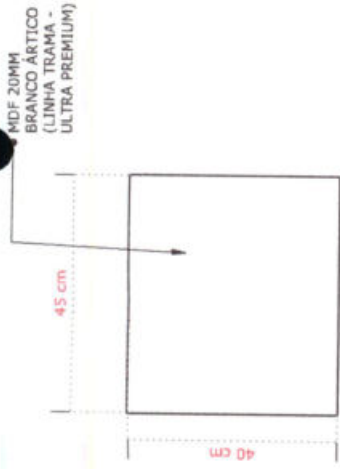

03 - VISTA SUPERIOR MBS  
ESCALA.....1/10

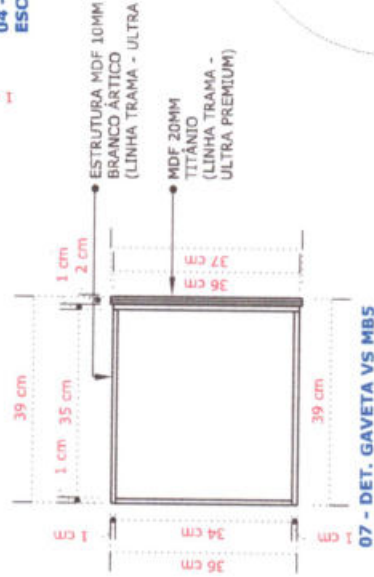

07 - DET. GAVETA VS MBS  
ESCALA.....1/10

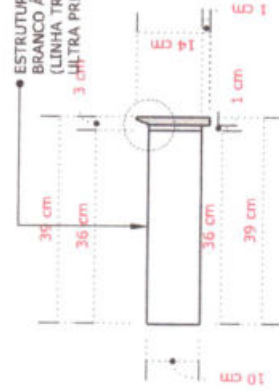

08 - DET. GAVETA VL MBS  
ESCALA.....1/10

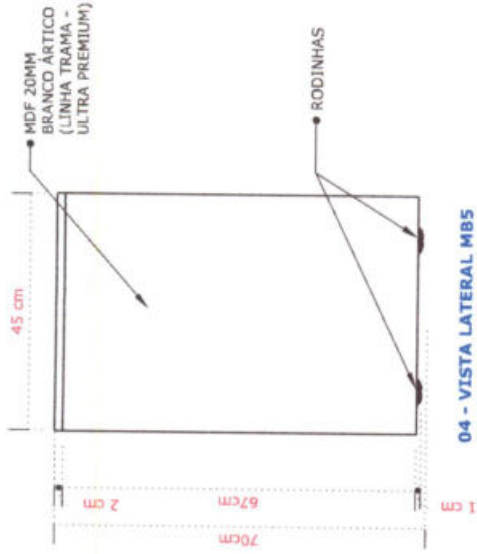

04 - VISTA LATERAL MBS  
ESCALA.....1/10

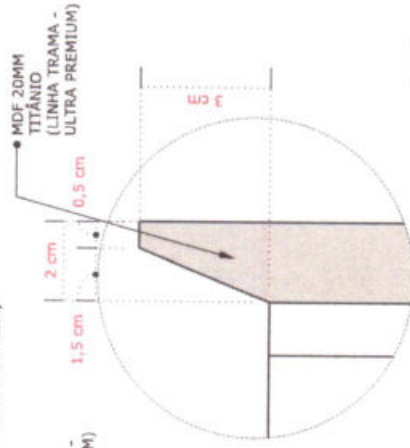

09 - DET. PUXADOR CAVA MBS  
SEM ESCALA



ATENÇÃO: CONFERIR MEDIDAS DOS AMBIENTES ANTES DE EXECUTAR OS MÓVEIS

**MOBILIÁRIO CENTRO DE IMAGENS DE HORIZONTE**

PROPRIETÁRIO: PREFEITURA MUNICIPAL DE HORIZONTE

AUTOR DO PROJETO: ARQ. GEFFERSON RAFAEL- CAU Nº A261764-1

LOCAL: HORIZONTE - CE

DATA: OUTUBRO - 2023

**CONTEÚDO:**

- 01- ISOMÉTRICA MBS.....1/10
- 02- PLANTA BAIXA MBS.....1/10
- 03- VISTA SUPERIOR MBS.....1/10
- 04- VISTA LATERAL MBS.....1/10
- 05- VISTA FRONTAL MBS.....1/10
- 06- CORTE LATERAL MBS.....1/10
- 07- DET. GAVETA VS MBS.....1/10
- 08- DET. GAVETA VL MBS.....1/10
- 09- DET. PUXADOR CAVA MBS...S/E

PRANCHA:

06 / 65





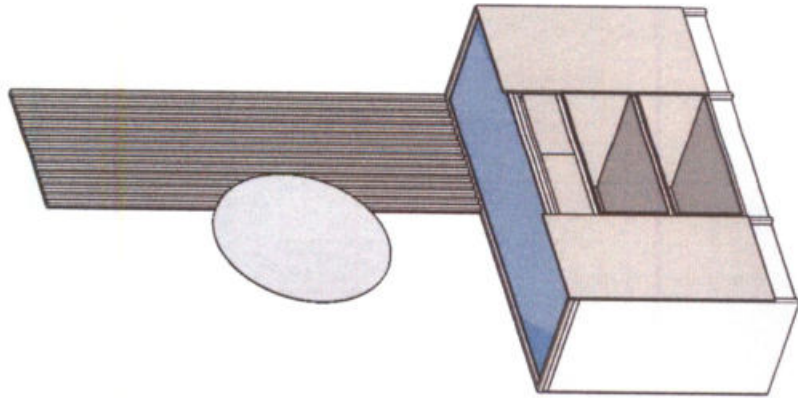

01 - ISOMÉTRICA MB6  
ESCALA.....1/20

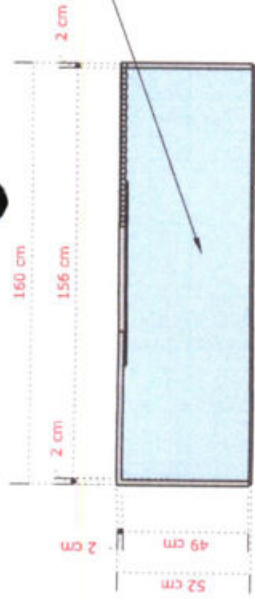

TAMPO DE VIDRO TEMPERADO  
8MM INCOLOR  
MEDIDAS=156cm x 49cm

02 - VISTA SUPERIOR MB6  
ESCALA.....1/20

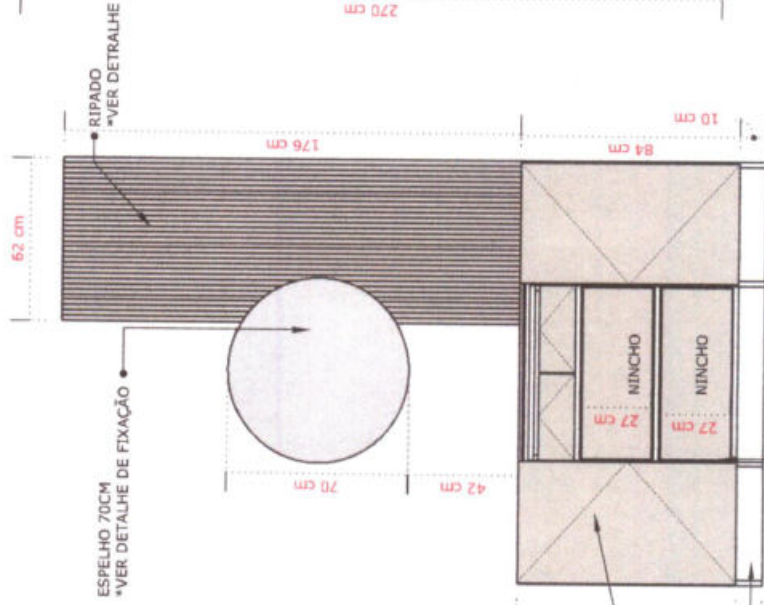

ESPELHO 70CM  
\*VER DETALHE DE FIXAÇÃO

RIPADO  
\*VER DETRALHE

DET. FIXAÇÃO  
ESPELHO

MDF 20 MM  
BRANCO ÁRTICO  
(LINHA TRAMA -  
ULTRA PREMIUM)

03 - VISTA FRONTAL MB6  
ESCALA.....1/20

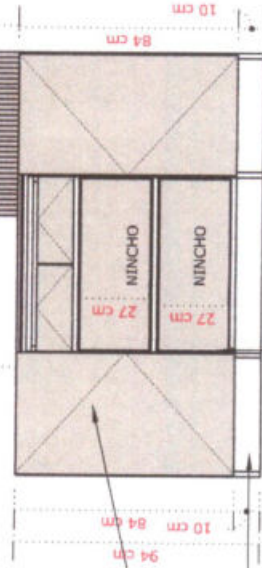

MDF 6MM  
TITÂNIO  
LINHA TRAMA

MDF 20MM  
TITÂNIO  
(LINHA TRAMA -  
ULTRA PREMIUM)

MDF 20 MM  
BRANCO ÁRTICO  
(LINHA TRAMA -  
ULTRA PREMIUM)

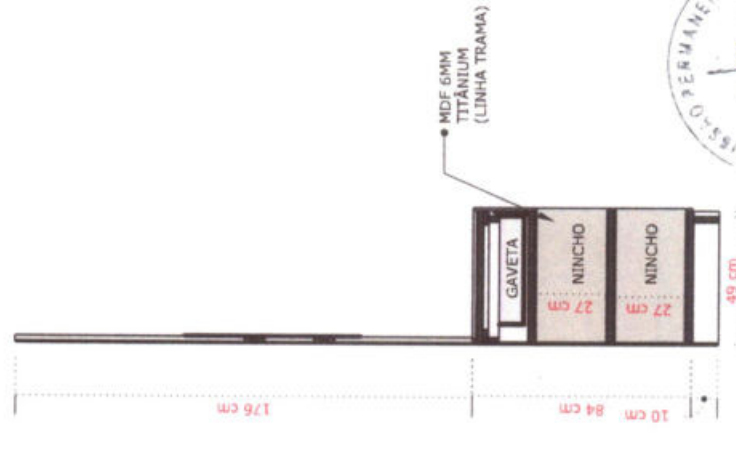

05 - CORTE LATERAL MB6  
ESCALA.....1/20

MDF 6MM  
TITÂNIO  
(LINHA TRAMA)

GAVETA  
NINCHO  
NINCHO



ATENÇÃO: CONFERIR MEDIDAS DOS AMBIENTES ANTES DE EXECUTAR OS MÓVEIS

**MOBILIÁRIO CENTRO DE IMAGENS DE HORIZONTE**

PROPRIETÁRIO: PREFEITURA MUNICIPAL DE HORIZONTE

AUTOR DO PROJETO: ARQ. GEFERSON RAFAEL- CAU Nº A261764-1

LOCAL: HORIZONTE - CE

DATA: OUTUBRO - 2023

**CONTEÚDO:**

- 01- ISOMÉTRICO MB6.....1/20
- 02- VISTA SUPERIOR MB6.....1/20
- 03- VISTA FRONTAL MB6.....1/20
- 04- VISTA LATERAL MB6.....1/20
- 05- CORTE LATERAL MB6.....1/20

PRANCHA:

07/65



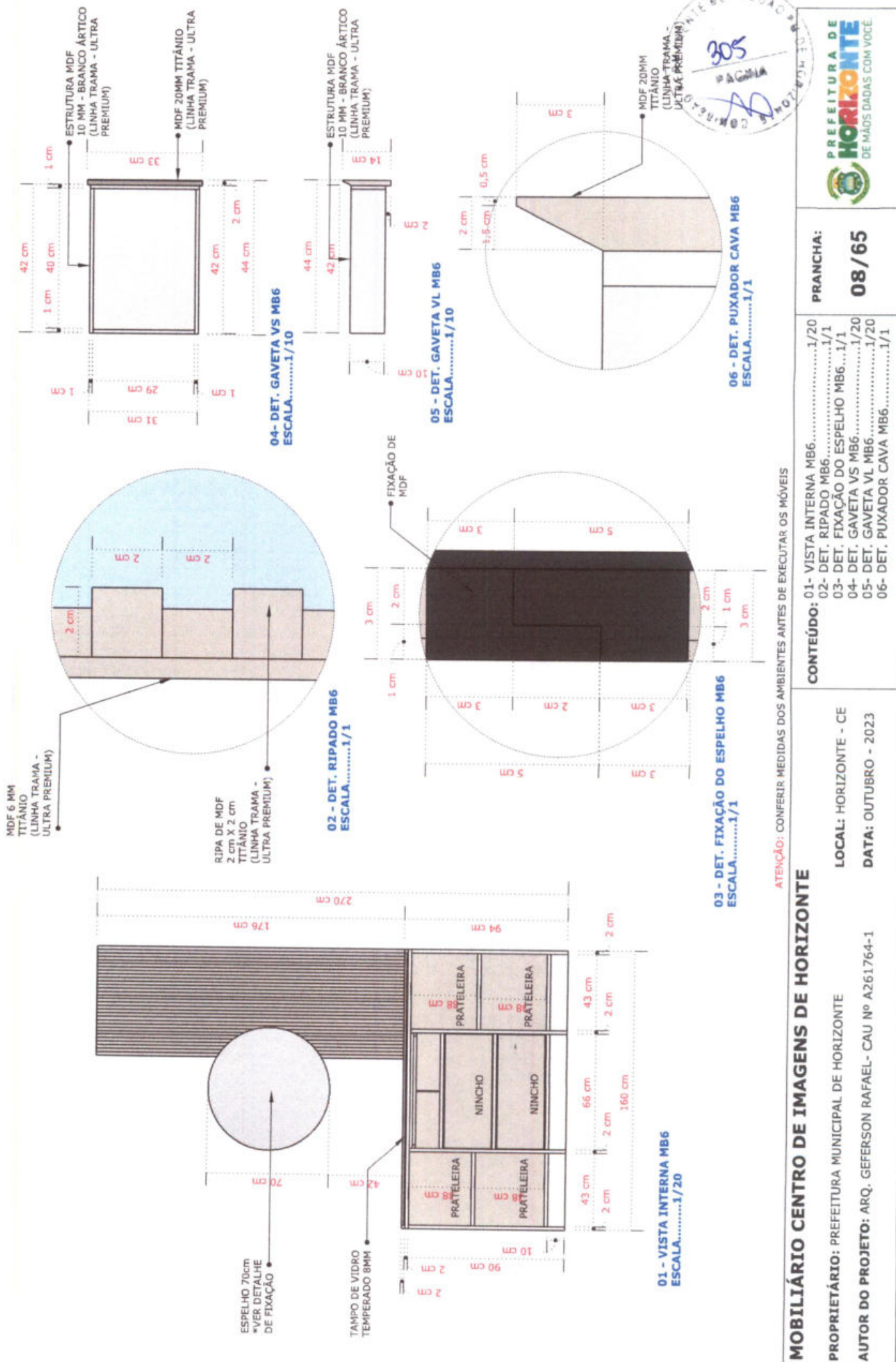

MDF 6 MM  
TITÂNIO  
(LINHA TRAMA -  
ULTRA PREMIUM)

ESTRUTURA MDF  
10 MM - BRANCO ÁRTICO  
(LINHA TRAMA - ULTRA  
PREMIUM)

MDF 20MM TITÂNIO  
(LINHA TRAMA - ULTRA  
PREMIUM)

ESTRUTURA MDF  
10 MM - BRANCO ÁRTICO  
(LINHA TRAMA - ULTRA  
PREMIUM)

MDF 20MM  
TITÂNIO  
(LINHA TRAMA -  
ULTRA PREMIUM)

RIPA DE MDF  
2 cm X 2 cm  
TITÂNIO  
(LINHA TRAMA -  
ULTRA PREMIUM)

ESPELHO 70cm  
\*VER DETALHE  
DE FIXAÇÃO

TAMPO DE VIDRO  
TEMPERADO 8MM

01 - VISTA INTERNA MB6  
ESCALA.....1/20

02 - DET. RIPADO MB6  
ESCALA.....1/1

03 - DET. FIXAÇÃO DO ESPELHO MB6  
ESCALA.....1/1

04 - DET. GAVETA VS MB6  
ESCALA.....1/10

05 - DET. GAVETA VL MB6  
ESCALA.....1/10

06 - DET. PUXADOR CAVA MB6  
ESCALA.....1/1

ATENÇÃO: CONFERIR MEDIDAS DOS AMBIENTES ANTES DE EXECUTAR OS MÓVEIS

**MOBILIÁRIO CENTRO DE IMAGENS DE HORIZONTE**

PROPRIETÁRIO: PREFEITURA MUNICIPAL DE HORIZONTE

AUTOR DO PROJETO: ARQ. GEFERSON RAFAEL- CAU Nº A2.61764-1

LOCAL: HORIZONTE - CE

DATA: OUTUBRO - 2023

CONTEÚDO:

01- VISTA INTERNA MB6.....	1/20
02- DET. RIPADO MB6.....	1/1
03- DET. FIXAÇÃO DO ESPELHO MB6.....	1/1
04- DET. GAVETA VS MB6.....	1/20
05- DET. GAVETA VL MB6.....	1/20
06- DET. PUXADOR CAVA MB6.....	1/1

PRANCHA:

**08/65**



305



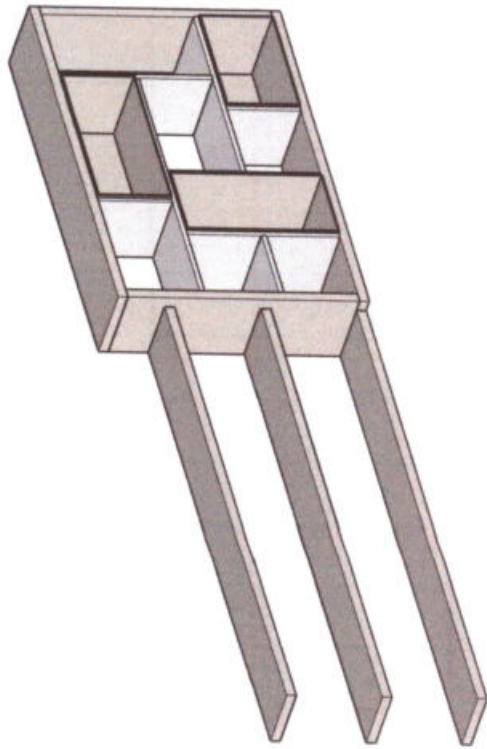

01 - ISOMÉTRICO MB7  
ESCALA.....1/10

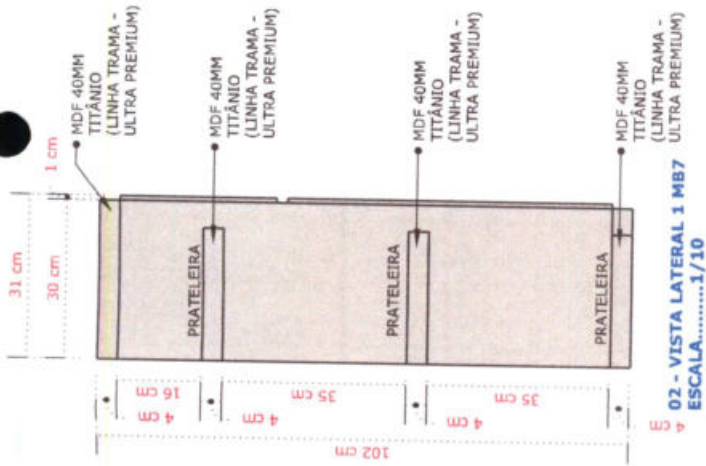

02 - VISTA LATERAL 1 MB7  
ESCALA.....1/10

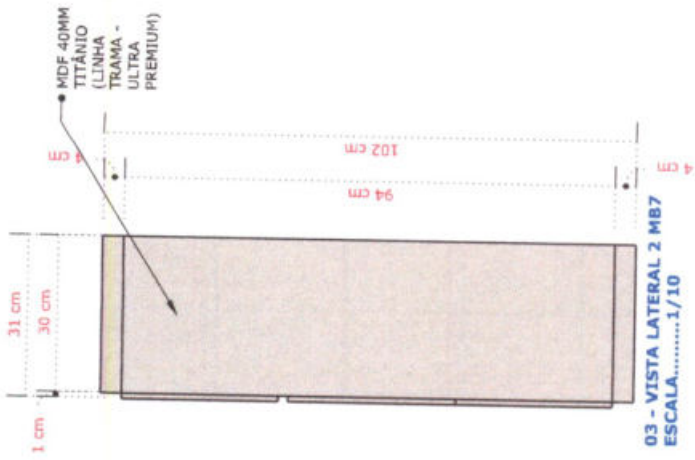

03 - VISTA LATERAL 2 MB7  
ESCALA.....1/10

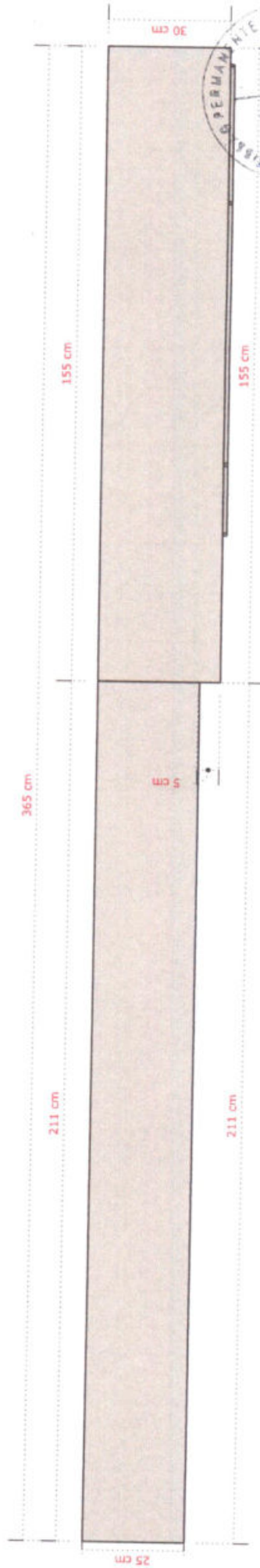

04 - VISTA SUPERIOR MB7  
ESCALA.....1/10

ATENÇÃO: CONFERIR MEDIDAS DOS AMBIENTES ANTES DE EXECUTAR OS MÓVEIS

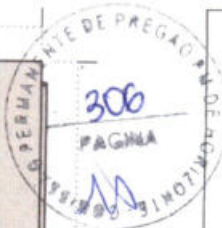

**MOBILIÁRIO CENTRO DE IMAGENS DE HORIZONTE**

PROPRIETÁRIO: PREFEITURA MUNICIPAL DE HORIZONTE  
AUTOR DO PROJETO: ARQ. GEFERSON RAFAEL- CAU Nº A261.764-1

LOCAL: HORIZONTE - CE  
DATA: OUTUBRO - 2023

**CONTEÚDO:**

- 01- ISOMÉTRICA MB7 .....1/10
- 02- VISTA LATERAL 1 MB7 .....1/10
- 03- VISTA LATERAL 2 MB7 .....1/10
- 04- VISTA SUPERIOR MB7 .....1/10

**PRANCHA:**

**09 / 65**



*(Handwritten signature)*





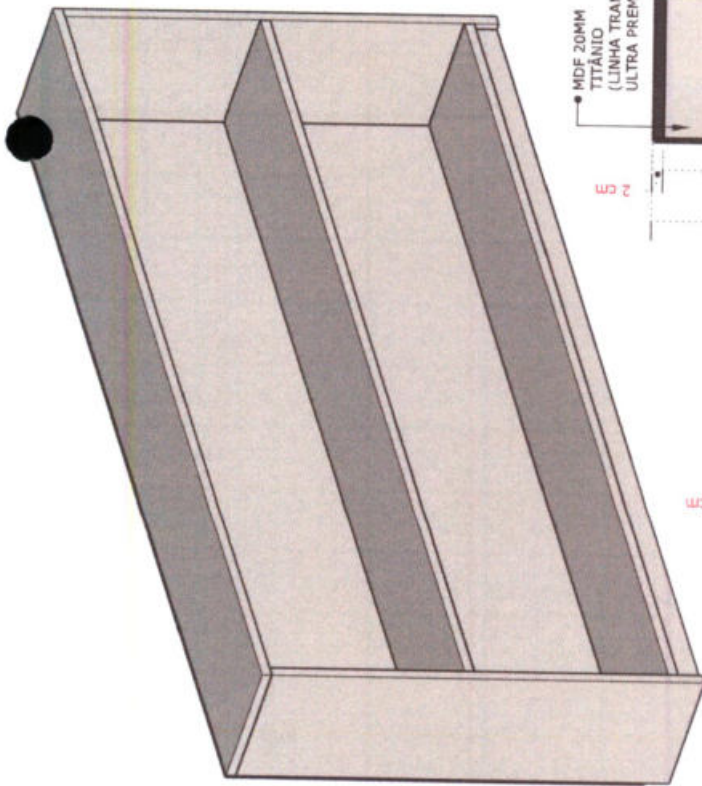

01 - ISMÉTRICA MBS  
ESCALA.....1/10

FUNDO: MDF 6MM  
TITÂNIO  
(LINHA TRAMA)

MDF 20MM  
TITÂNIO  
(LINHA TRAMA -  
ULTRA PREMIUM)

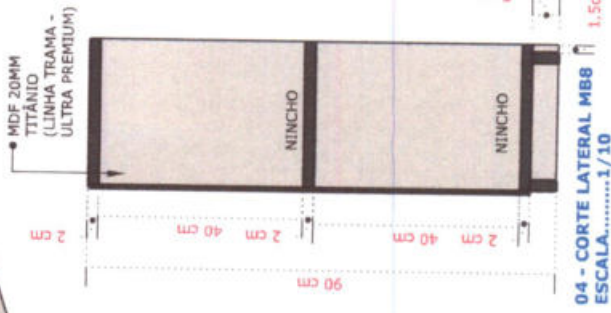
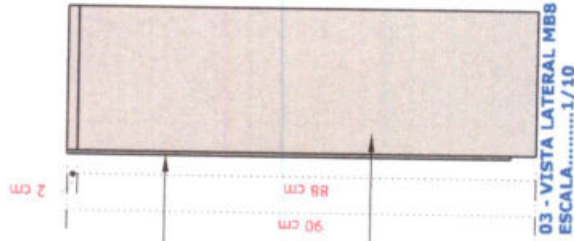

MDF 20MM  
TITÂNIO  
(LINHA TRAMA -  
ULTRA PREMIUM)

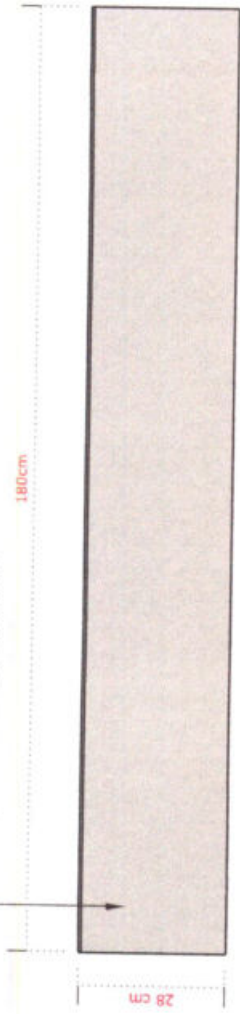

FUNDO: MDF 6MM  
TITÂNIO  
(LINHA TRAMA - ULTRA PREMIUM)

180 cm  
175 cm

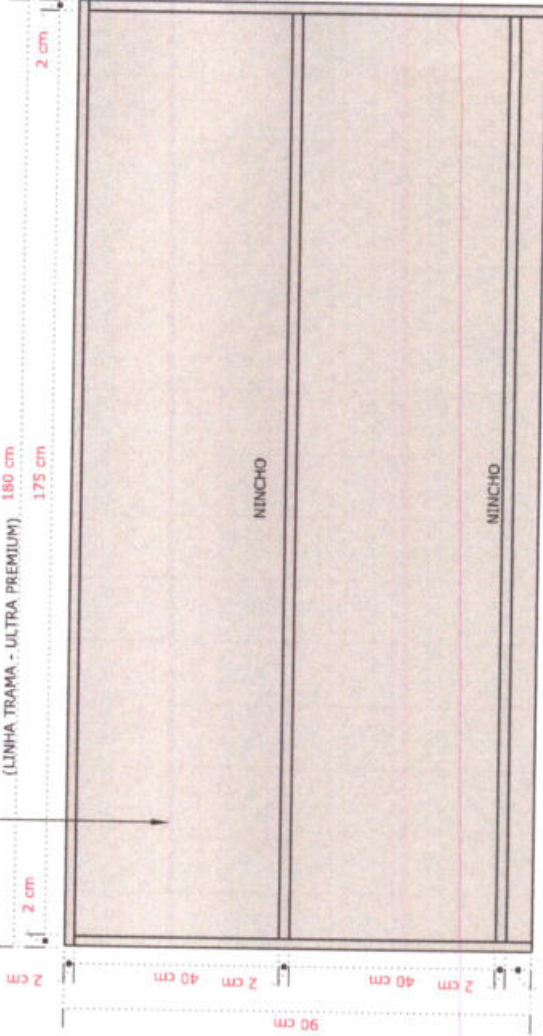

ATENÇÃO: CONFERIR MEDIDAS DOS AMBIENTES ANTES DE EXECUTAR OS MÓVEIS

**MOBILIÁRIO CENTRO DE IMAGENS DE HORIZONTE**

PROPRIETÁRIO: PREFEITURA MUNICIPAL DE HORIZONTE

LOCAL: HORIZONTE - CE

AUTOR DO PROJETO: ARQ. GEFERSON RAFAEL- CAU Nº A261764-1

DATA: OUTUBRO - 2023

**CONTEÚDO:**

- 01- ISOMÉTRICA MBS.....1/10
- 02- VISTA SUPERIOR MBS.....1/10
- 03- VISTA LATERAL MBS.....1/10
- 04- CORTE LATERAL MBS.....1/10
- 05- VISTA FRONTAL MBS.....1/10

**PRANCHA:**

**11/65**



*(Handwritten signature)*

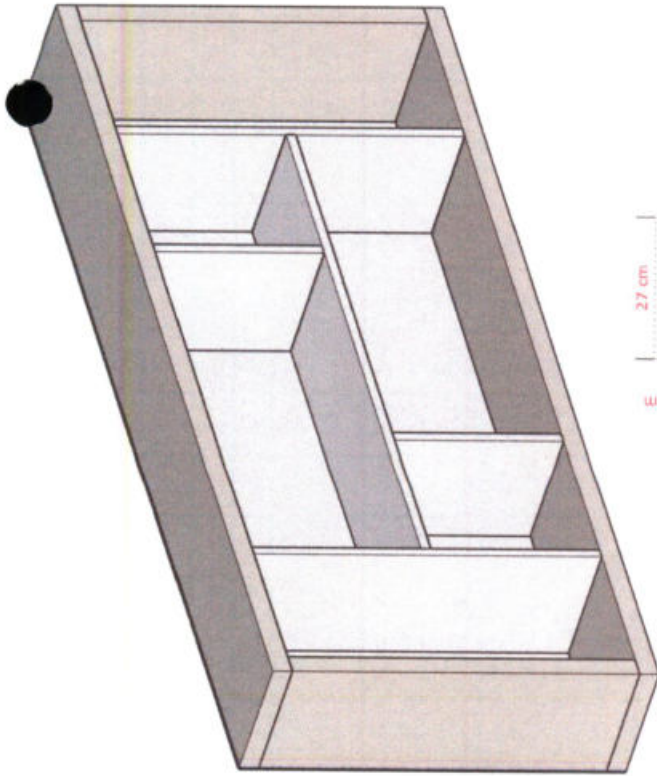

**01 - ISOMÉTRICA MB9**  
ESCALA.....1/10

MDF 40MM  
TITÂNIO  
(LINHA TRAMA -  
ULTRA PREMIUM)

FUNDO MDF 6MM  
BRANCO ÁRTICO  
(LINHA TRAMA)

MDF 40MM  
TITÂNIO  
(LINHA TRAMA -  
ULTRA PREMIUM)

MDF 40MM  
TITÂNIO  
(LINHA TRAMA -  
ULTRA PREMIUM)

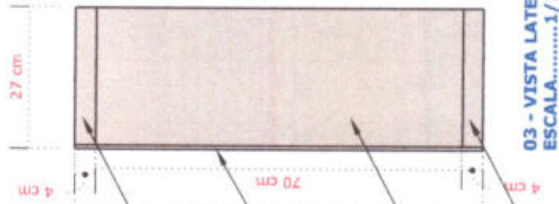

**03 - VISTA LATERAL MB9**  
ESCALA.....1/10

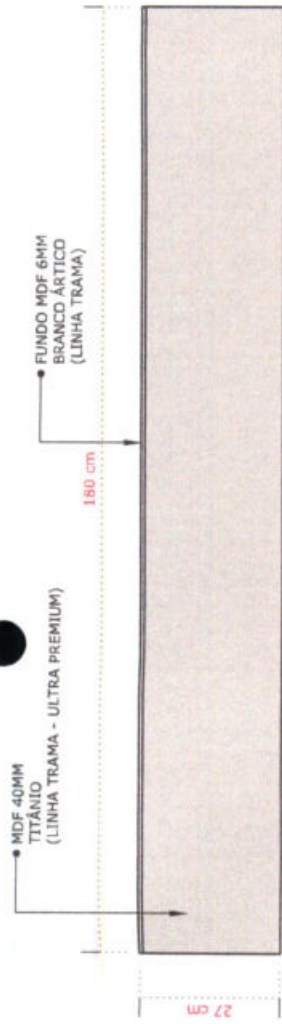

**02 - VISTA SUPERIOR MB9**  
ESCALA.....1/10

MDF 40MM  
TITÂNIO  
(LINHA TRAMA -  
ULTRA PREMIUM)

FUNDO MDF 6MM  
BRANCO ÁRTICO  
(LINHA TRAMA)

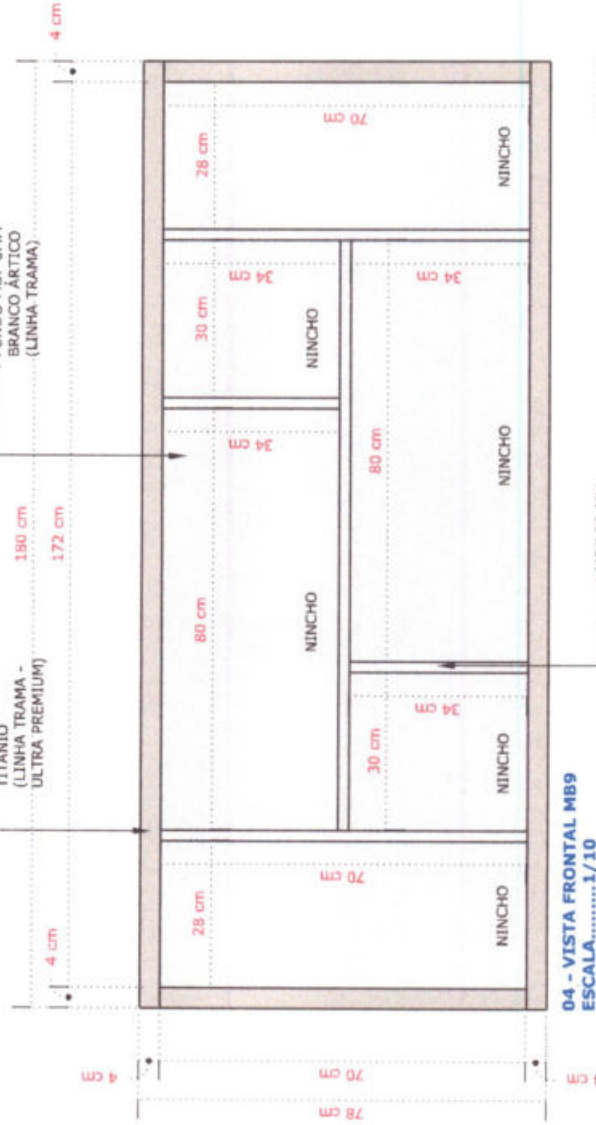

**04 - VISTA FRONTAL MB9**  
ESCALA.....1/10

MDF 20 MM  
BRANCO ÁRTICO  
(LINHA TRAMA - ULTRA PREMIUM)



ATENÇÃO: CONFERIR MEDIDAS DOS AMBIENTES ANTES DE EXECUTAR OS MÓVEIS

**MOBILIÁRIO CENTRO DE IMAGENS DE HORIZONTE**

PROPRIETÁRIO: PREFEITURA MUNICIPAL DE HORIZONTE

AUTOR DO PROJETO: ARQ. GEFERSON RAFAEL- CAU Nº A261764-1

LOCAL: HORIZONTE - CE

DATA: OUTUBRO - 2023

**CONTEÚDO:**

- 01- ISOMÉTRICA MB09.....1/10
- 02- VISTA SUPERIOR MB9.....1/10
- 03- VISTA LATERAL MB9.....1/10
- 04-VISTA FRONTAL MB9.....1/10

PRANCHA:

**12/65**



*(Handwritten signature)*



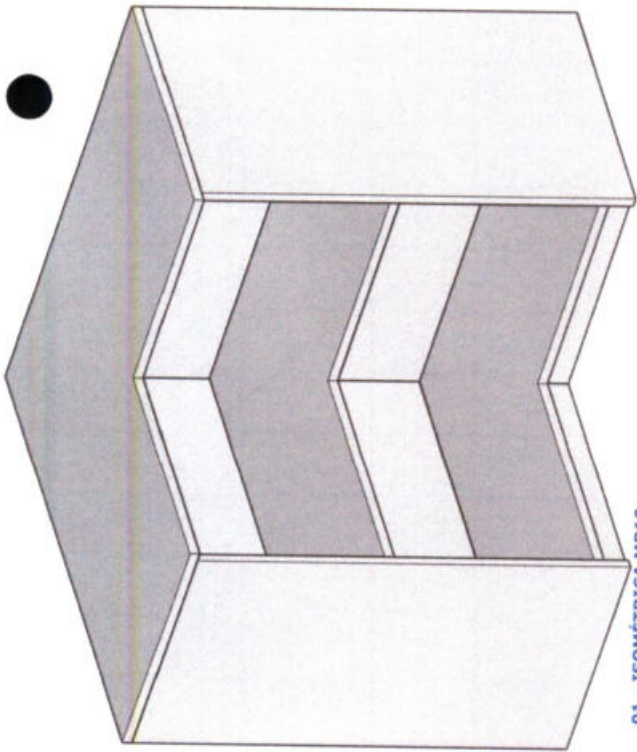

01 - ISOMÉTRICA MB10  
ESCALA.....1/10

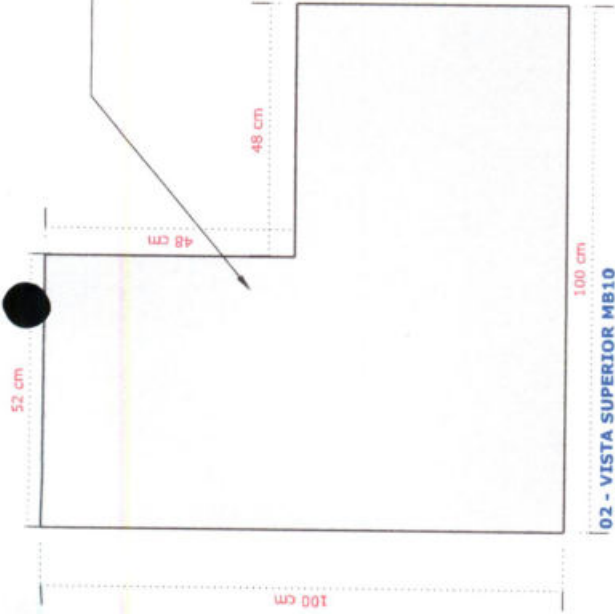

02 - VISTA SUPERIOR MB10  
ESCALA.....1/10

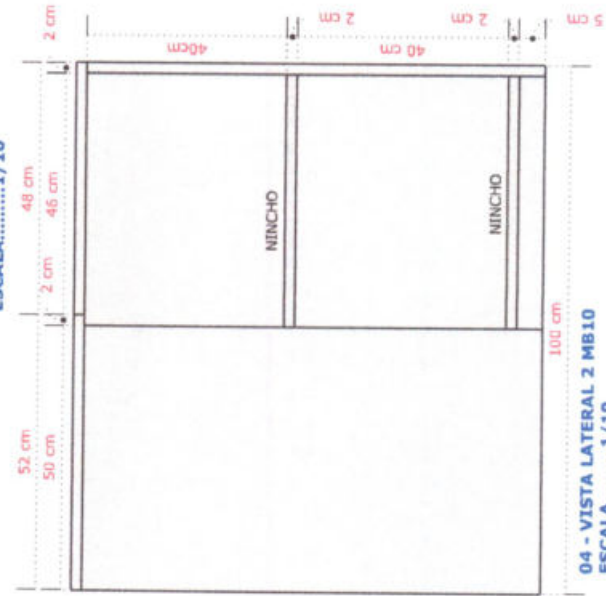

04 - VISTA LATERAL 2 MB10  
ESCALA.....1/10

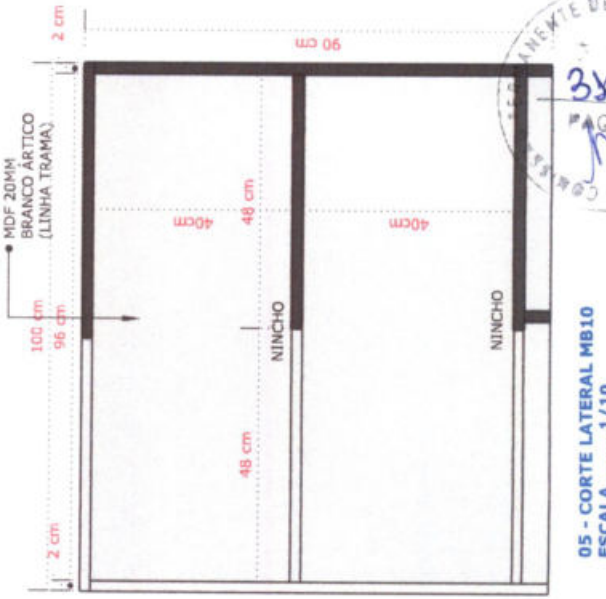

05 - CORTE LATERAL MB10  
ESCALA.....1/10



ATENÇÃO: CONFERIR MEDIDAS DOS AMBIENTES ANTES DE EXECUTAR OS MÓVEIS

**MOBILIÁRIO CENTRO DE IMAGENS DE HORIZONTE**

PROPRIETÁRIO: PREFEITURA MUNICIPAL DE HORIZONTE  
AUTOR DO PROJETO: ARQ. GEFERSON RAFAEL- CAU Nº A261764-1

LOCAL: HORIZONTE - CE  
DATA: OUTUBRO - 2023

**CONTEÚDO:**

- 01- ISOMÉTRICA MB10.....1/10
- 02- VISTA SUPERIOR MB10.....1/10
- 03- VISTA LATERAL 1 MB10.....1/10
- 04- VISTA LATERAL 2 MB10.....1/10
- 05- CORTE LATERAL MB10.....1/10

PRANCHA:

**13/65**



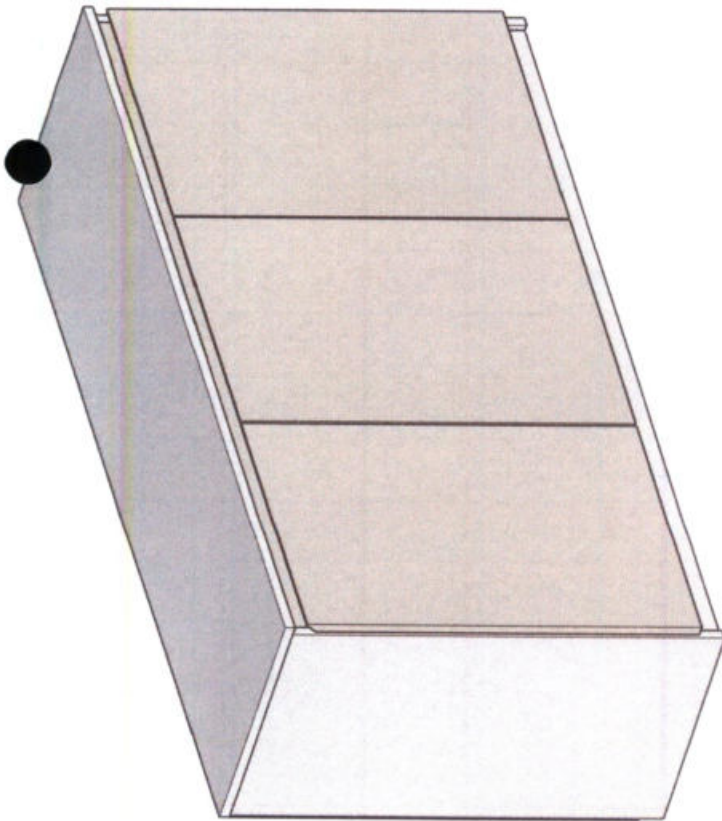

01 - ISOMÉTRICA MB11  
ESCALA.....1/10

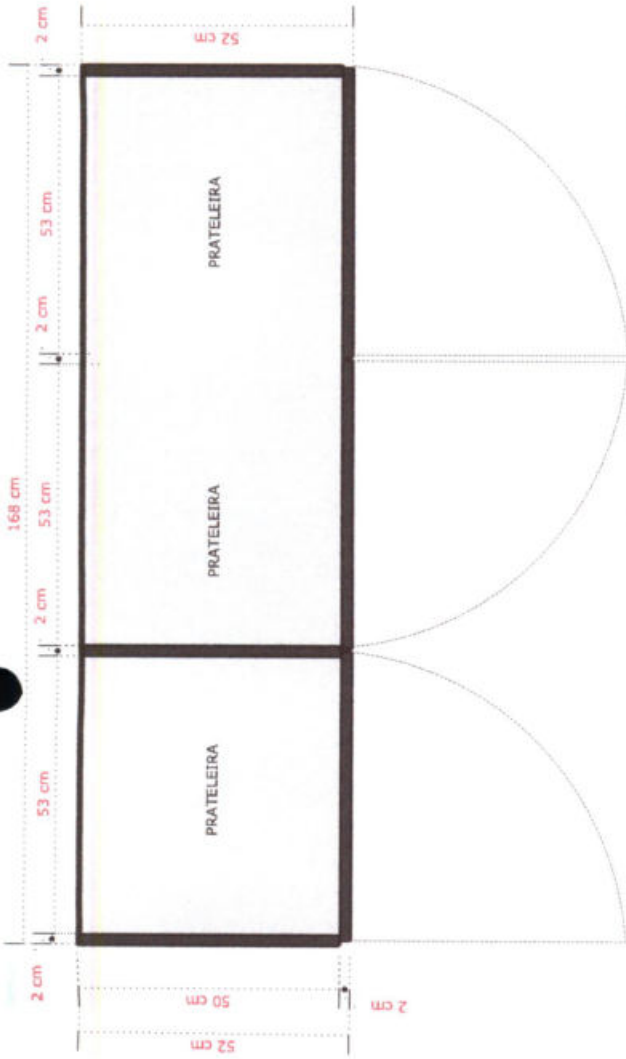

02 - PLANTA BAIXA MB11  
ESCALA.....1/10

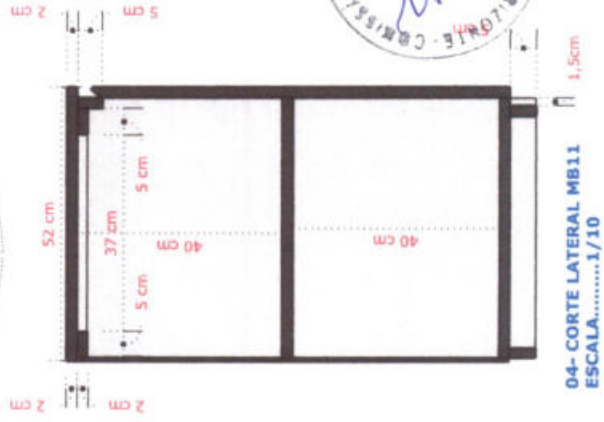

04- CORTE LATERAL MB11  
ESCALA.....1/10

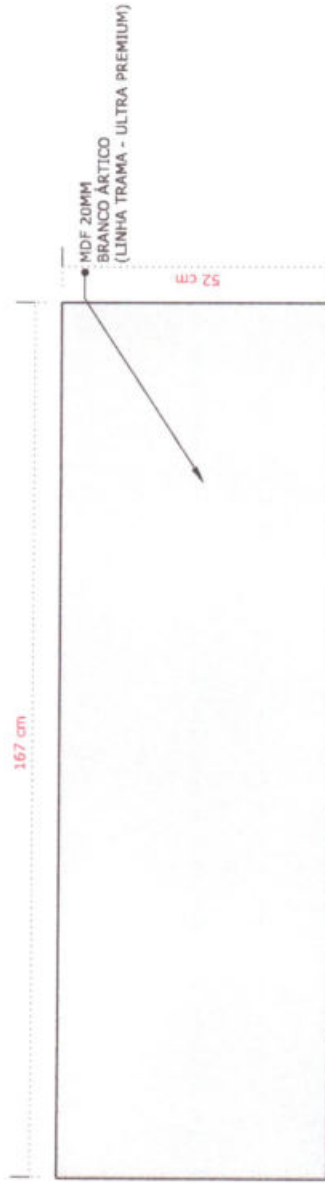

03- VISTA SUPERIOR MB11  
ESCALA.....1/10

ATENÇÃO: CONFERIR MEDIDAS DOS AMBIENTES ANTES DE EXECUTAR OS MÓVEIS



**MOBILIÁRIO CENTRO DE IMAGENS DE HORIZONTE**

PROPRIETÁRIO: PREFEITURA MUNICIPAL DE HORIZONTE

LOCAL: HORIZONTE - CE

AUTOR DO PROJETO: ARQ. GEFERSON RAFAEL- CAU Nº A261764-1

DATA: OUTUBRO - 2023

**CONTEÚDO:**

- 01- ISOMÉTRICA MB11.....1/10
- 02-PLANTA BAIXA MB11.....1/10
- 03-VISTA SUPERIOR MB11.....1/10
- 04- CORTE LATERAL MB11.....1/10

**PRANCHA:**

**14/65**





MDF 20MM  
BRANCO ÁRTICO  
(LINHA TRAMA -  
ULTRA PREMIUM)

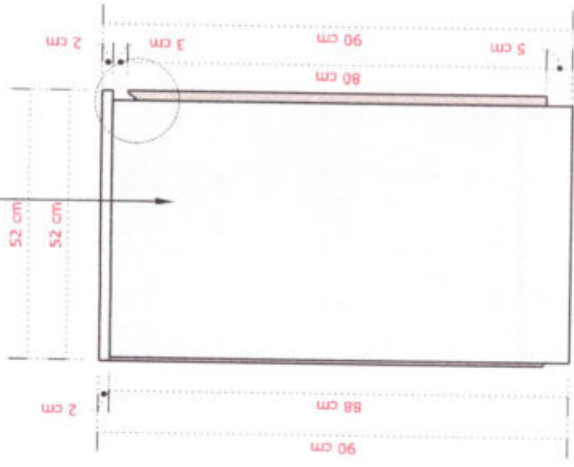

01 - VISTA LATERAL MB11  
ESCALA.....1/10

MDF 20MM  
TITÂNIO  
(LINHA TRAMA -  
ULTRA PREMIUM)

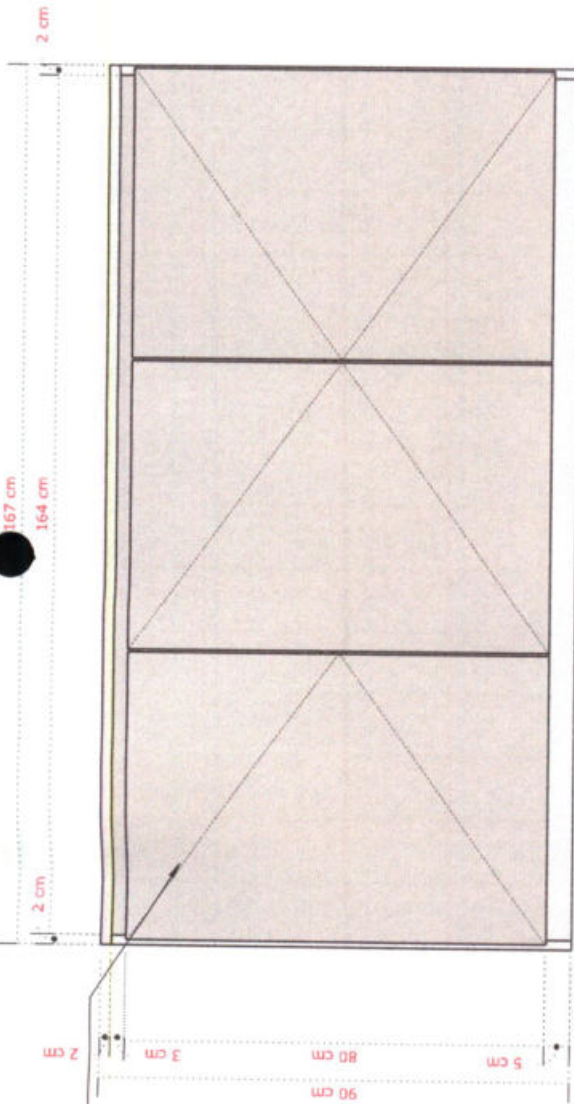

02 - VISTA FRONTAL MB11  
ESCALA.....1/10

MDF 20MM  
TITÂNIO  
(LINHA TRAMA -  
ULTRA PREMIUM)

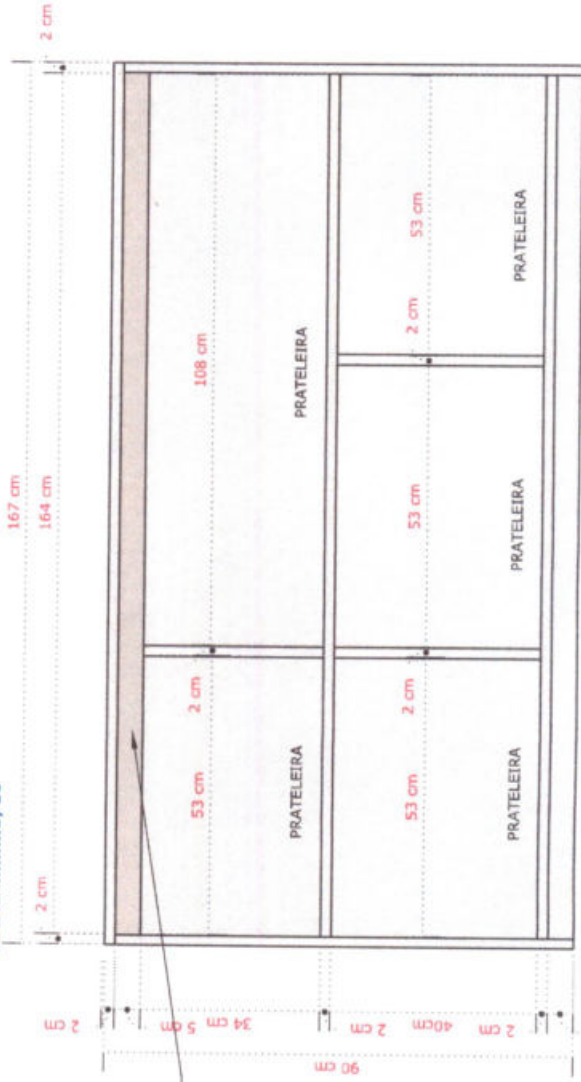

04 - VISTA INTERNA MB11  
ESCALA.....1/10

03 - DET. PUXADOR CAVA MB11  
ESCALA.....1/10

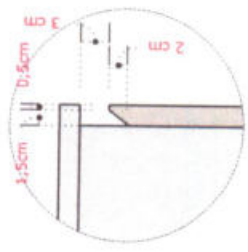

ATENÇÃO: CONFERIR MEDIDAS DOS AMBIENTES ANTES DE EXECUTAR OS MÓVEIS

**MOBILIÁRIO CENTRO DE IMAGENS DE HORIZONTE**

PROPRIETÁRIO: PREFEITURA MUNICIPAL DE HORIZONTE

AUTOR DO PROJETO: ARQ. GEFFERSON RAFAEL- CAU Nº A261764-1

LOCAL: HORIZONTE - CE

DATA: OUTUBRO - 2023

**CONTEÚDO:**

- 01- VISTA LATERAL MB11.....1/10
- 02- VISTA FRONTAL MB11.....1/10
- 03- DET. PUXADOR CAVA MB11.....1/10
- 04- VISTA INTERNA MB11.....1/10

**PRANCHA:**

**15/65**



*(Handwritten signature)*

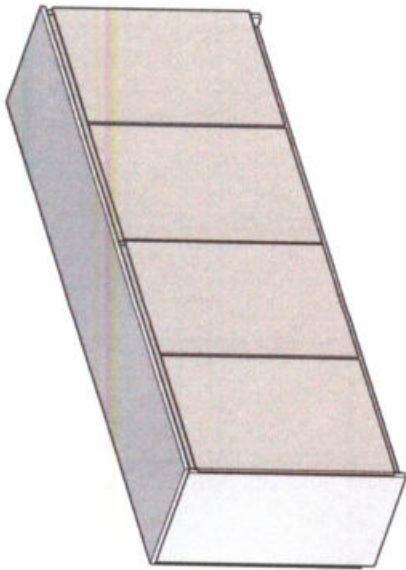

01 - ISOMETRICA MB12  
ESCALA.....1/20

MDF 20MM  
BRANCO ÁRTICO  
(LINHA TRAMA - ULTRA PREMIUM)



02 - VISTA SUPERIOR MB12  
ESCALA.....1/10

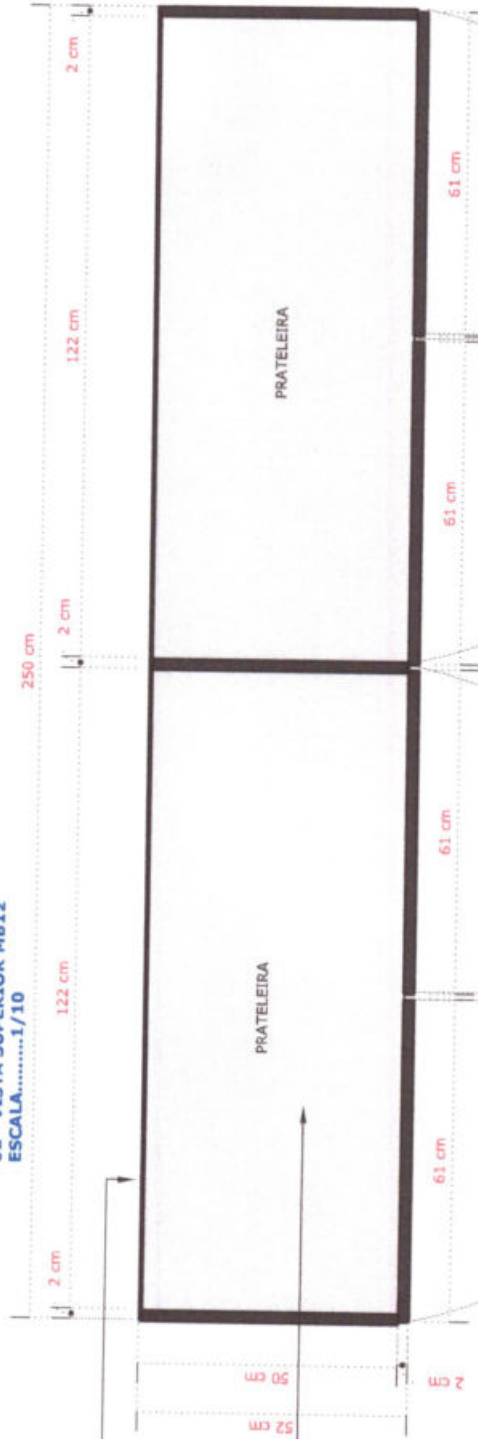

FUNDO MDF-6MM  
BRANCO ÁRTICO  
(LINHA TRAMA)

MDF 20MM  
BRANCO ÁRTICO  
(LINHA TRAMA -  
ULTRA PREMIUM)

03 - PLANTA BAIXA MB12  
ESCALA.....1/10

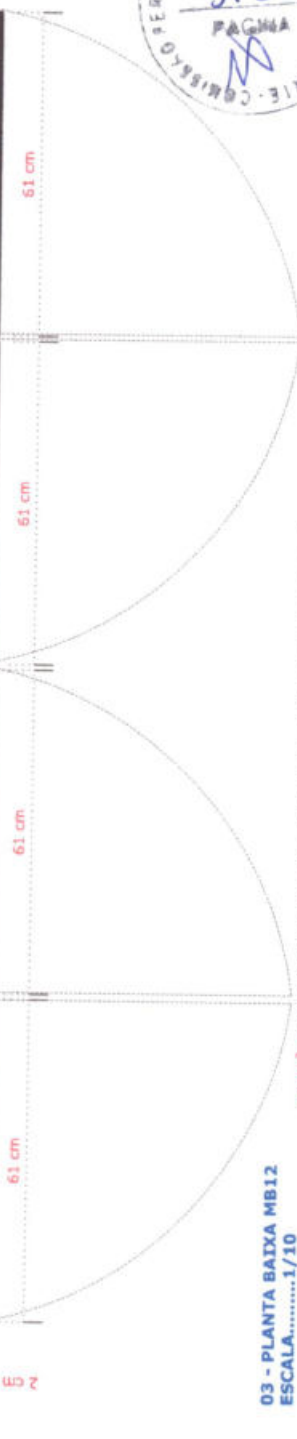

ATENÇÃO: CONFERIR MEDIDAS DOS AMBIENTES ANTES DE EXECUTAR OS MÓVEIS



**MOBILIÁRIO CENTRO DE IMAGENS DE HORIZONTE**

PROPRIETÁRIO: PREFEITURA MUNICIPAL DE HORIZONTE

LOCAL: HORIZONTE - CE

AUTOR DO PROJETO: ARQ. GEFERSON RAFAEL - CAU Nº A261764-1

DATA: OUTUBRO - 2023

**CONTEÚDO:**

- 01- ISOMÉTRICA MB12.....1/20
- 02-VISTA SUPERIOR MB12.....1/10
- 03-PLANTA BAIXA MB12.....1/10

PRANCHA:

**16/65**



*(Handwritten signature)*



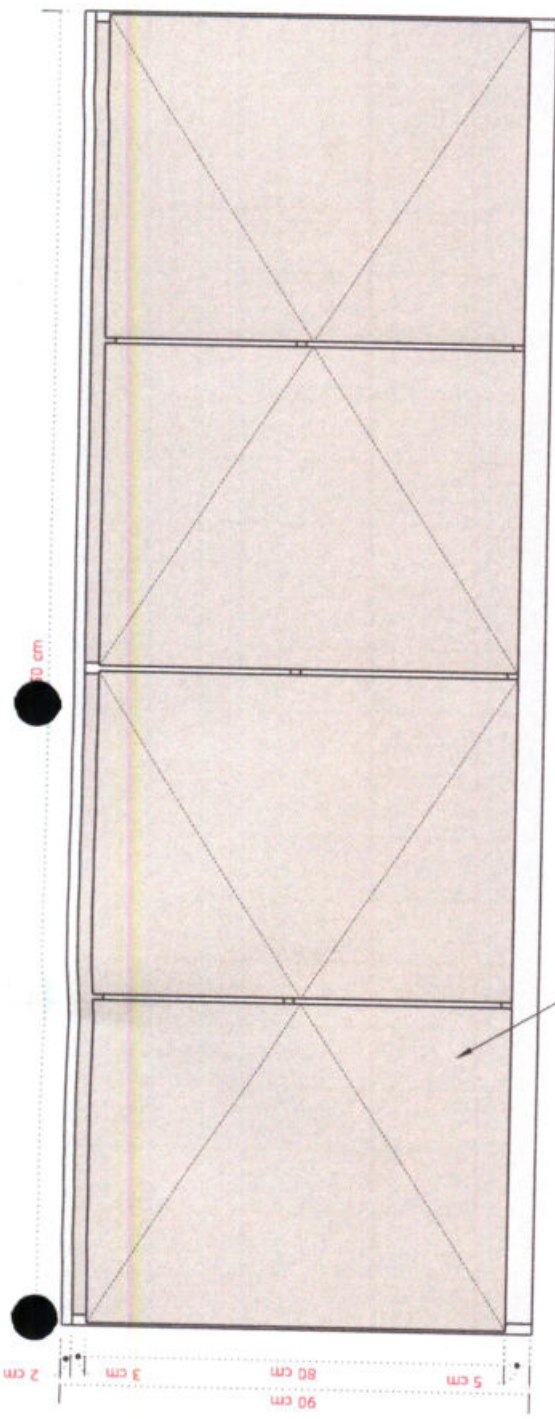

02 - VISTA LATERAL MB12  
ESCALA.....1/10

MDF 20MM  
TITÂNIO  
(LINHA TRAMA - ULTRA PREMIUM)

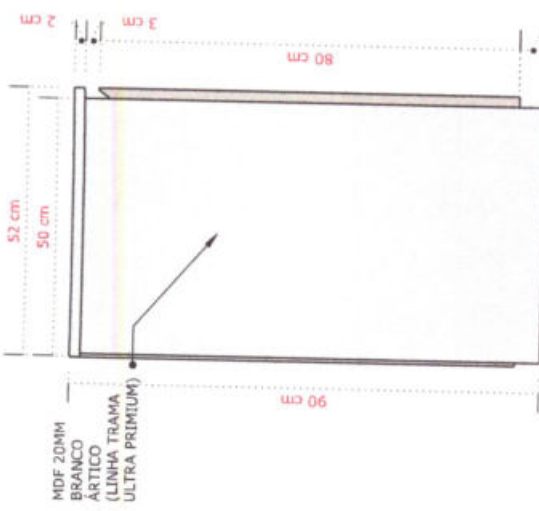

01 - VISTA LATERAL MB12  
ESCALA.....1/10

MDF 20MM  
BRANCO  
ÁRTICO  
(LINHA TRAMA  
ULTRA PREMIUM)

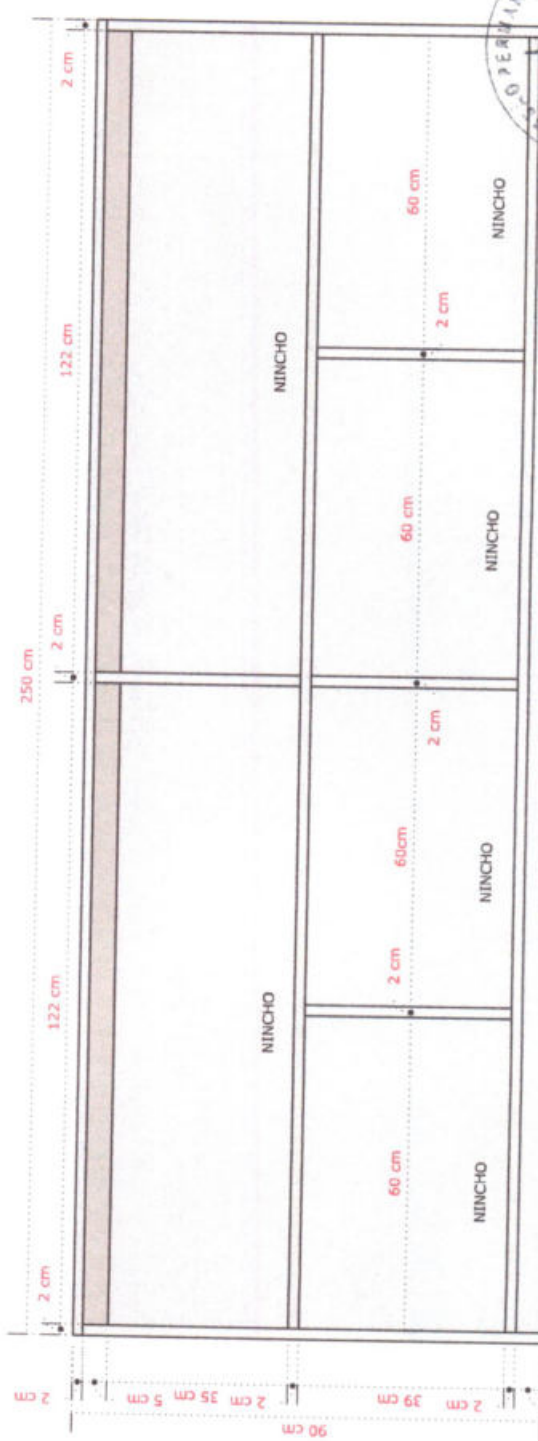

04 - VISTA INTERNA MB12  
ESCALA.....1/10

ATENÇÃO: CONFERIR MEDIDAS DOS AMBIENTES ANTES DE EXECUTAR OS MÓVEIS

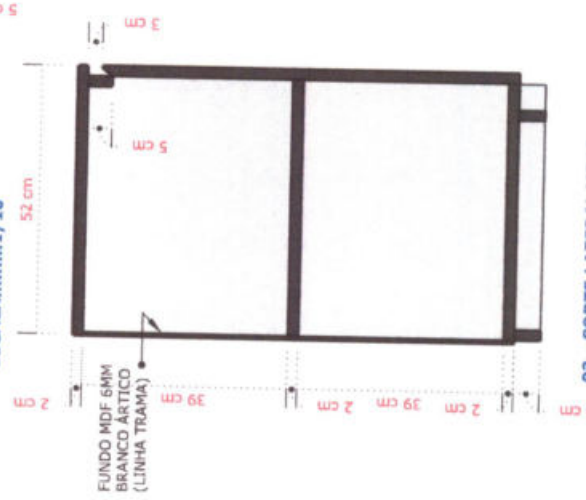

03 - CORTE LATERAL MB12  
ESCALA.....1/10

FUNDO MDF 6MM  
BRANCO ÁRTICO  
(LINHA TRAMA)



**MOBILIÁRIO CENTRO DE IMAGENS DE HORIZONTE**

PROPRIETÁRIO: PREFEITURA MUNICIPAL DE HORIZONTE

AUTOR DO PROJETO: ARQ. GEFERSON RAFAEL- CAU Nº A261764-1

LOCAL: HORIZONTE - CE

DATA: OUTUBRO - 2023

**CONTEÚDO:**

- 01- VISTA LATERAL MB12.....1/10
- 02- VISTA LATERAL MB12.....1/10
- 03- CORTE LATERAL MB12.....1/10
- 04- VISTA INTERNA MB12.....1/10

PRANCHA:

**17 / 65**



*(Handwritten signature)*

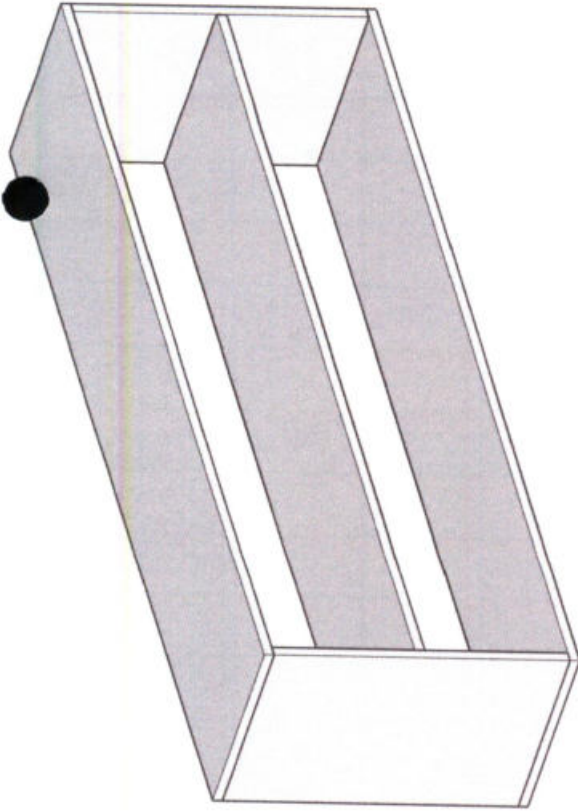

01 - ISOMÉTRICA MB13  
ESCALA.....1/10

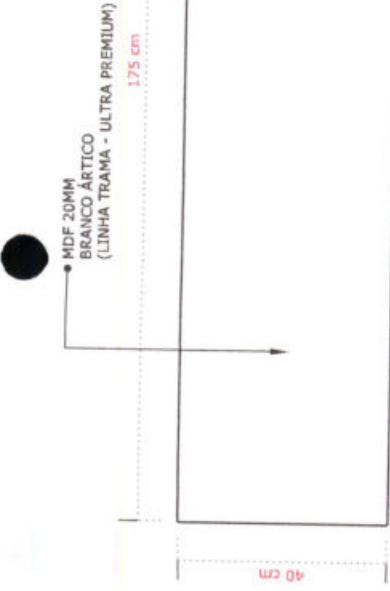

02 - VISTA SUPERIOR MB13  
ESCALA.....1/10

MDF 20MM  
BRANCO ÁRTICO  
(LINHA TRAMA - ULTRA PREMIUM)

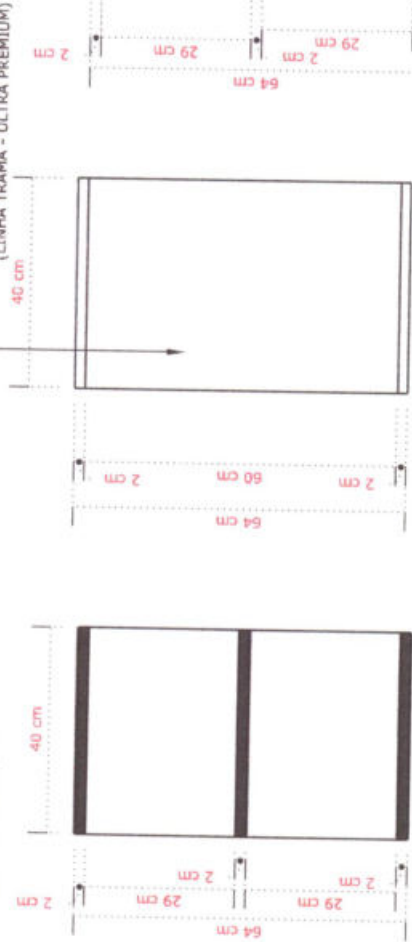

03 - CORTE LATERAL MB13  
ESCALA.....1/10



04 - VISTA LATERAL MB13  
ESCALA.....1/10

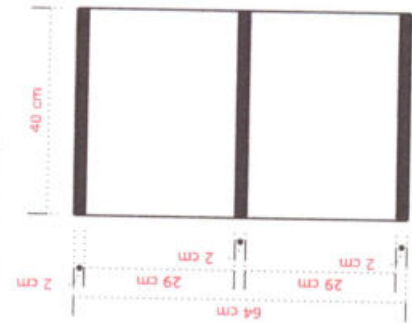

05 - VISTA FRONTAL MB13  
ESCALA.....1/10

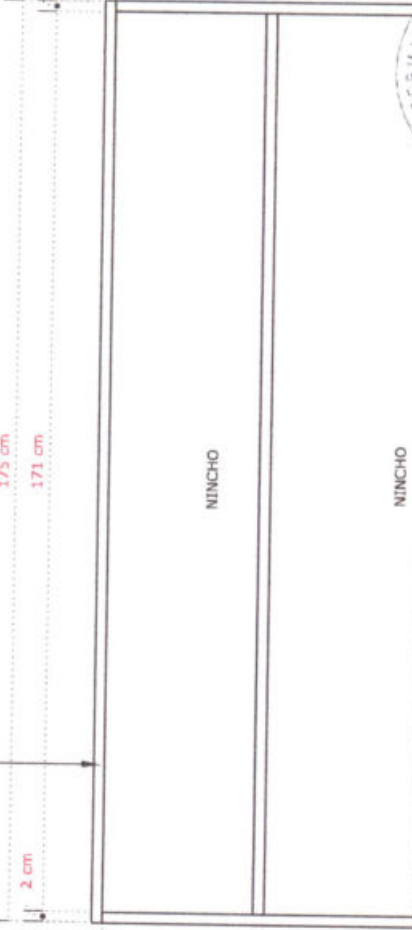

ATENÇÃO: CONFERIR MEDIDAS DOS AMBIENTES ANTES DE EXECUTAR OS MÓVEIS

<b>PRANCHA:</b> <b>18/65</b>	<b>CONTEÚDO:</b> 01- ISOMÉTRICA MB13.....1/10 02- VISTA SUPERIOR MB13.....1/10 03- CORTE LATERAL MB13.....1/10 04- VISTA LATERAL MB13.....1/10 05- VISTA FRONTAL MB13.....1/10
<b>MOBILIÁRIO CENTRO DE IMAGENS DE HORIZONTE</b> PROPRIETÁRIO: PREFEITURA MUNICIPAL DE HORIZONTE AUTOR DO PROJETO: ARQ. GEFERSON RAFAEL- CAU Nº A261764-1	LOCAL: HORIZONTE - CE DATA: OUTUBRO - 2023

*(Handwritten signature)*



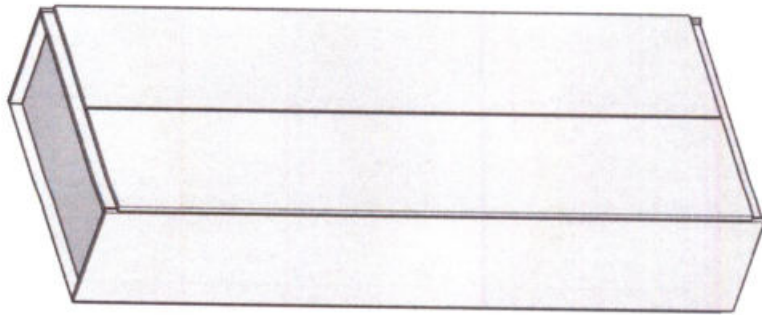

01 - ISOMÉTRICA MB14  
ESCALA.....1/20



02 - PLANTA BAIXA MB14  
ESCALA.....1/10

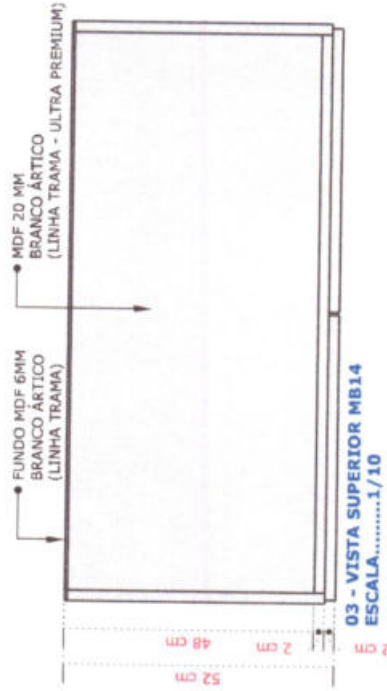

03 - VISTA SUPERIOR MB14  
ESCALA.....1/10

ATENÇÃO: CONFERIR MEDIDAS DOS AMBIENTES ANTES DE EXECUTAR OS MÓVEIS

**MOBILIÁRIO CENTRO DE IMAGENS DE HORIZONTE**

PROPRIETÁRIO: PREFEITURA MUNICIPAL DE HORIZONTE

AUTOR DO PROJETO: ARQ. GEFERSON RAFAEL- CAU Nº A261764-1

LOCAL: HORIZONTE - CE

DATA: OUTUBRO - 2023

**CONTEÚDO:**

- 01- ISOMÉTRICA MB14.....1/20
- 02- PLANTA BAIXA MB14.....1/10
- 03- VISTA SUPERIOR MB14.....1/10

PRANCHA:

**19/65**



*(Handwritten signature)*

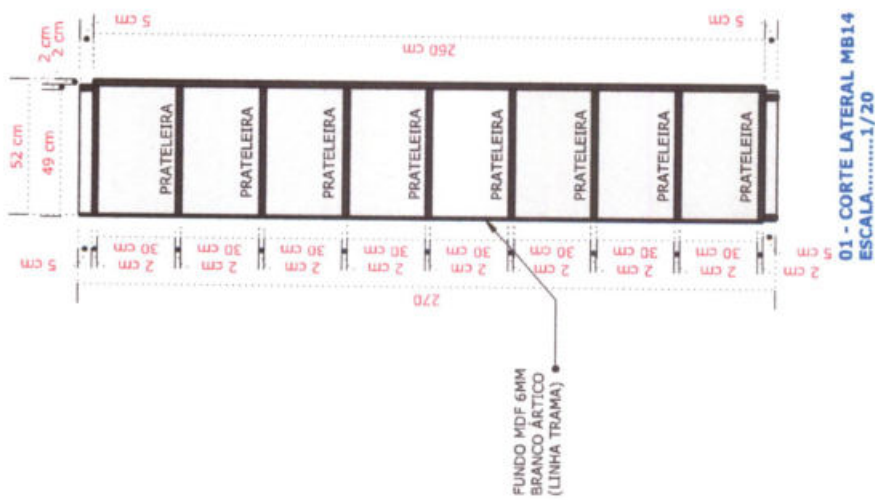

01 - CORTE LATERAL MB14  
ESCALA.....1/20

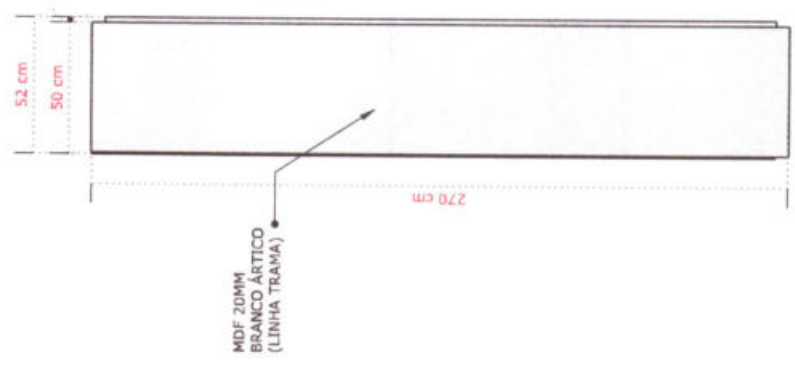

02 - VISTA LATERAL MB14  
ESCALA.....1/20

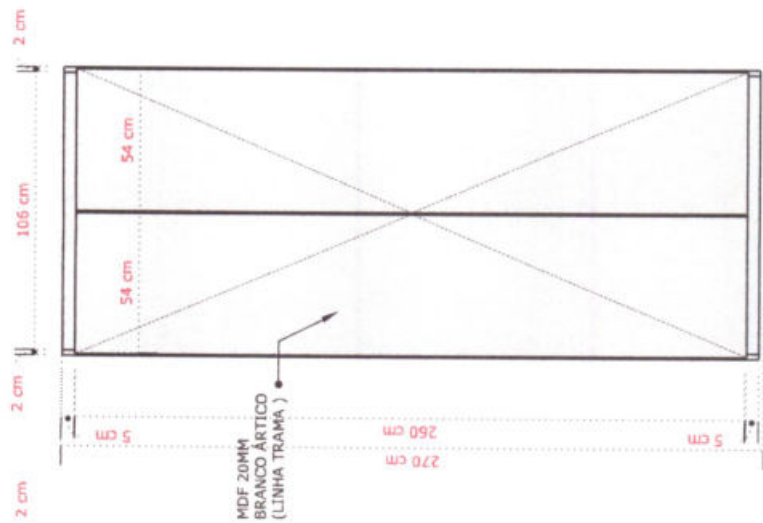

03 - VISTA FRONTAL MB14  
ESCALA.....1/20

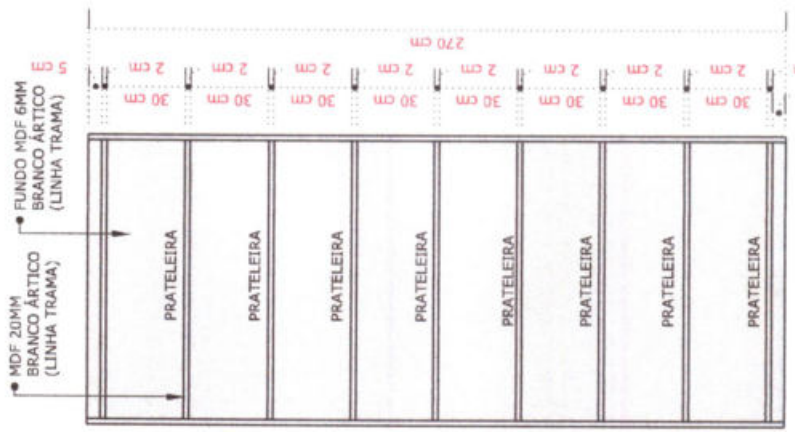

04 - VISTA INTERNA MB14  
ESCALA.....1/20



**MOBILIÁRIO CENTRO DE IMAGENS DE HORIZONTE**

PROPRIETÁRIO: PREFEITURA MUNICIPAL DE HORIZONTE

AUTOR DO PROJETO: ARQ. GEFERSON RAFAEL- CAU Nº A261764-1

LOCAL: HORIZONTE - CE

DATA: OUTUBRO - 2023

- CONTEÚDO:**
- 01- CORTE LATERAL MB14.....1/20
  - 02- VISTA LATERAL MB14.....1/20
  - 03- VISTA FRONTAL MB14.....1/20
  - 04- VISTA INTERNA MB14.....1/20

**PRANCHA:**  
**20 / 65**



*[Handwritten signature]*



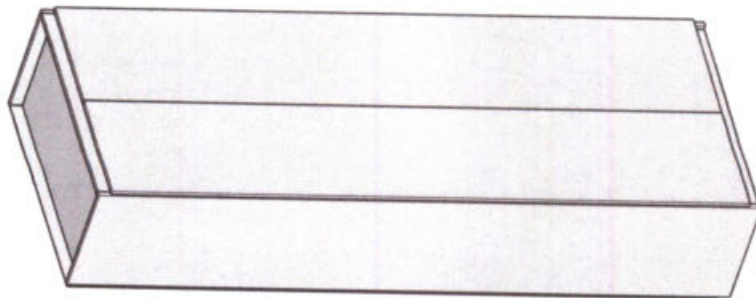

01 - ISOMÉTRICO MB15  
ESCALA.....1/20

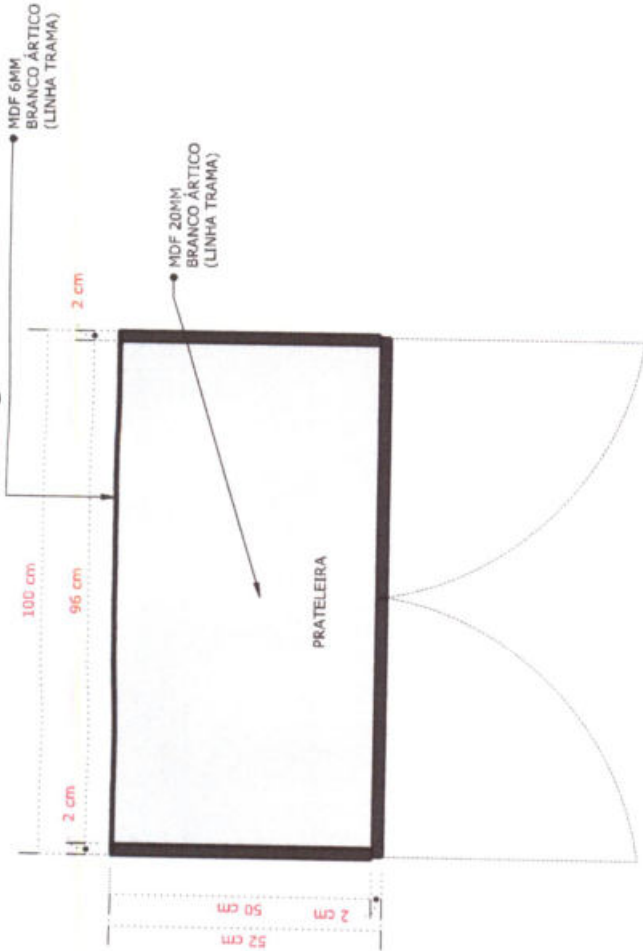

02 - PLANTA BAIXA MB15  
ESCALA.....1/10

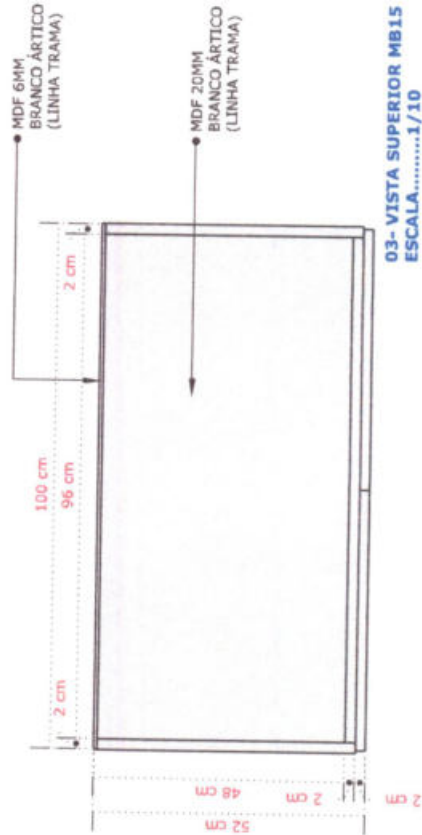

03- VISTA SUPERIOR MB15  
ESCALA.....1/10

ATENÇÃO: CONFERIR MEDIDAS DOS AMBIENTES ANTES DE EXECUTAR OS MÓVEIS



**MOBILIÁRIO CENTRO DE IMAGENS DE HORIZONTE**

PROPRIETÁRIO: PREFEITURA MUNICIPAL DE HORIZONTE  
AUTOR DO PROJETO: ARQ. GEFERSON RAFAEL- CAU Nº A261764-1

**CONTEÚDO:**

- 01- ISOMÉTRICA MB15.....1/20
- 02- PLANTA BAIXA MB15.....1/10
- 03- VISTA SUPERIOR MB15.....1/10

**PRANCHA:**

**21/65**



*(Handwritten signature)*

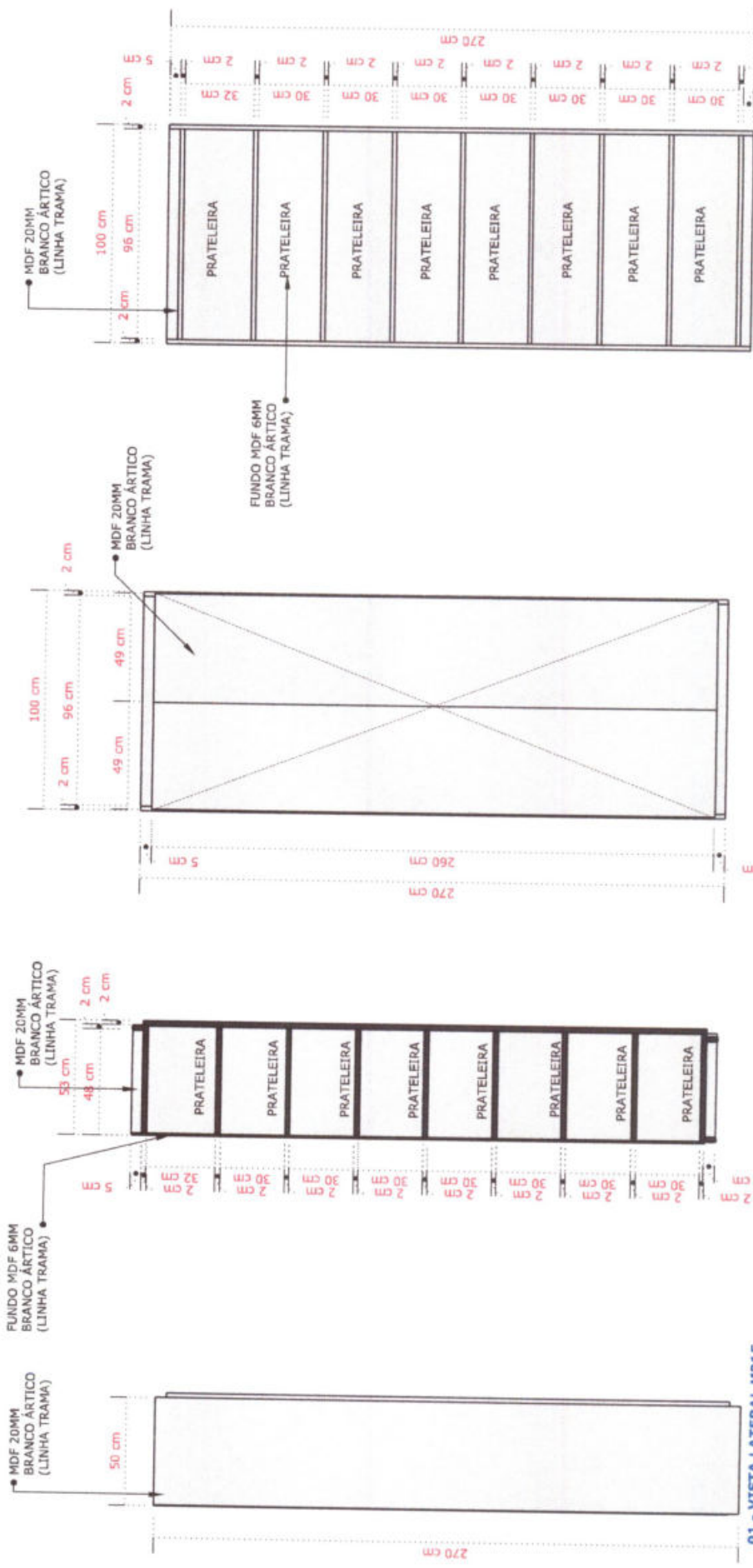

ATENÇÃO: CONFERIR MEDIDAS DOS AMBIENTES ANTES DE EXECUTAR OS MÓVEIS

<b>MOBILIÁRIO CENTRO DE IMAGENS DE HORIZONTE</b>	
PROPRIETÁRIO: PREFEITURA MUNICIPAL DE HORIZONTE AUTOR DO PROJETO: ARQ. GEFERSON RAFAEL - CAU Nº A261764-1	LOCAL: HORIZONTE - CE DATA: OUTUBRO - 2023
<b>CONTEÚDO:</b>	
01- VISTA LATERAL MB15.....1/20 02- CORTE LATERAL MB15.....1/20 03- VISTA FRONTAL MB15.....1/20 04- VISTA INTERNA MB15.....1/20	
<b>PRANCHA:</b>	<b>22/65</b>



*(Handwritten mark)*



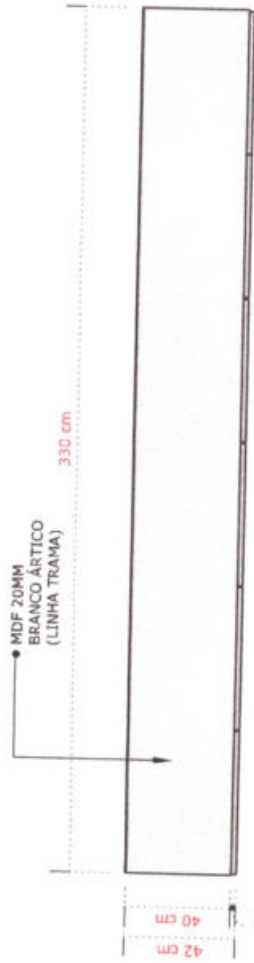
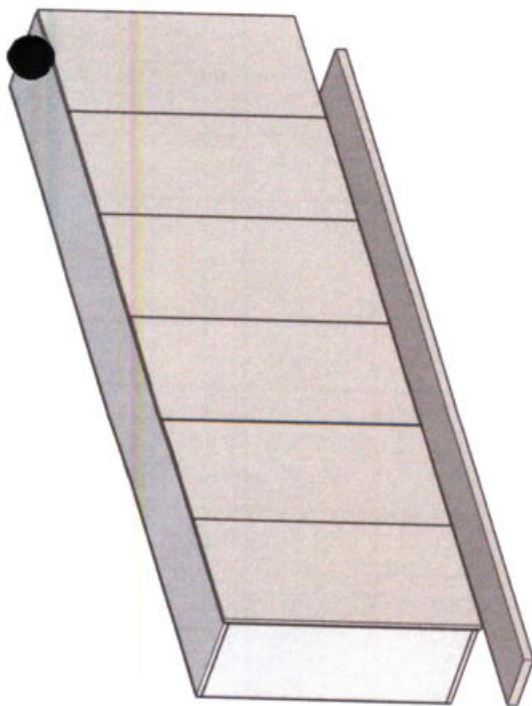

02- VISTA SUPERIOR MB16  
ESCALA.....1/20

01 - ISOMÉTRICA MB16  
ESCALA.....1/20

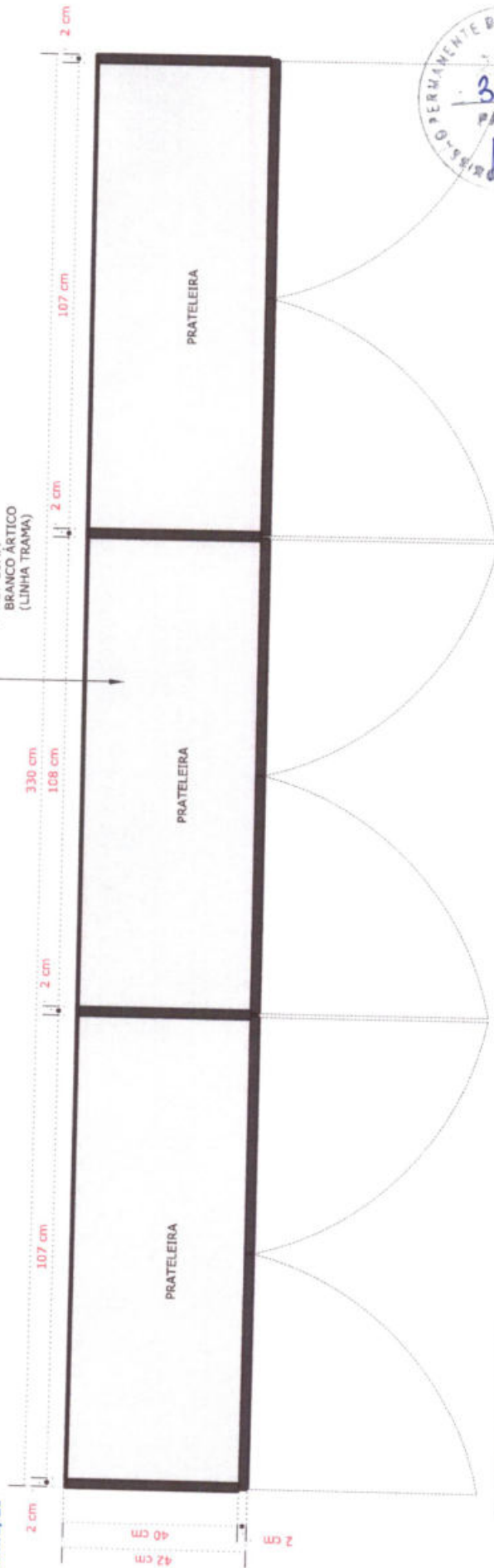

03- PLANTA BAIXA MB16  
ESCALA.....1/10

ATENÇÃO: CONFERIR MEDIDAS DOS AMBIENTES ANTES DE EXECUTAR OS MÓVEIS



**MOBILIÁRIO CENTRO DE IMAGENS DE HORIZONTE**

PROPRIETÁRIO: PREFEITURA MUNICIPAL DE HORIZONTE

LOCAL: HORIZONTE - CE

AUTOR DO PROJETO: ARQ. GEFERSON RAFAEL- CAU Nº A261764-1

DATA: OUTUBRO - 2023

**CONTEÚDO:**

- 01- ISOMÉTRICA MB16.....1/20
- 02- VISTA SUPERIOR MB16.....1/20
- 03- PLANTA BAIXA MB16.....1/10

**PRANCHA:**

**23 / 65**



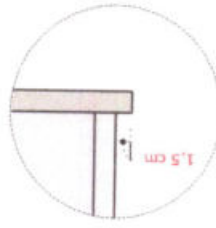
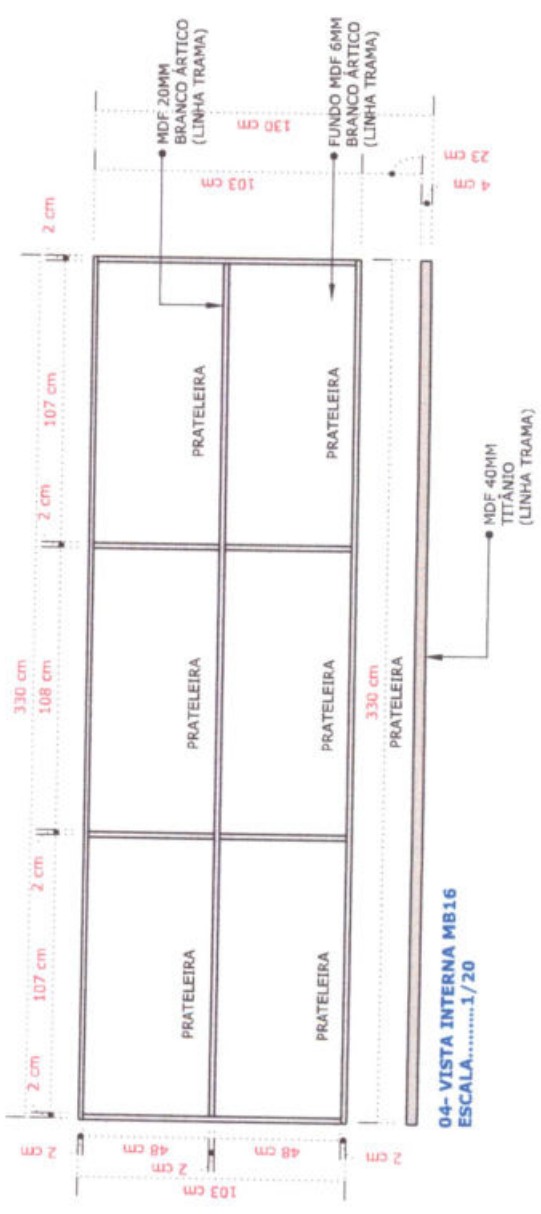
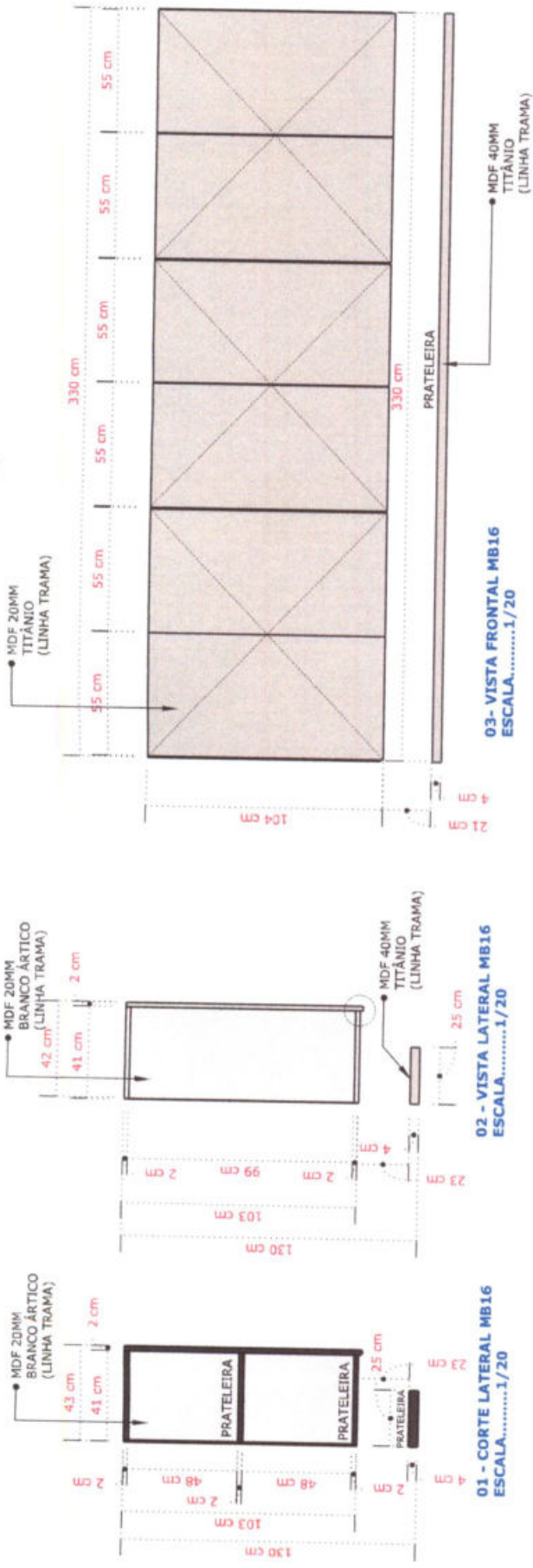

**05- DET. PUXADOR MB16**  
ESCALA.....1/5

ATENÇÃO: CONFERIR MEDIDAS DOS AMBIENTES ANTES DE EXECUTAR OS MÓVEIS



<b>MOBILIÁRIO CENTRO DE IMAGENS DE HORIZONTE</b>		<b>PRANCHA:</b> <b>24/65</b>	<b>PREFEITURA DE HORIZONTE</b> DE MÃOS DADAS COM VOCE
<b>PROPRIETÁRIO:</b> PREFEITURA MUNICIPAL DE HORIZONTE	<b>LOCAL:</b> HORIZONTE - CE	<b>CONTEÚDO:</b>	
<b>AUTOR DO PROJETO:</b> ARQ. GEFERSON RAFAEL- CAU Nº A261764-1	<b>DATA:</b> OUTUBRO - 2023	01- CORTE LATERAL MB16.....1/20	
		02- VISTA LATERAL MB16.....1/20	
		03- VISTA FRONTAL MB16.....1/20	
		04- VISTA INTERNA MB16.....1/20	
		05- DET. PUXADOR MB16.....1/5	

*(Handwritten signature)*





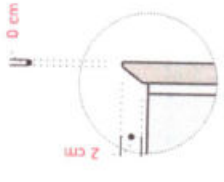
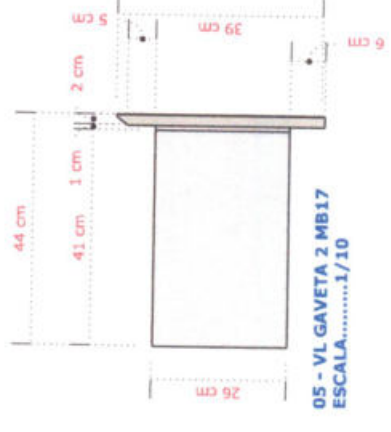
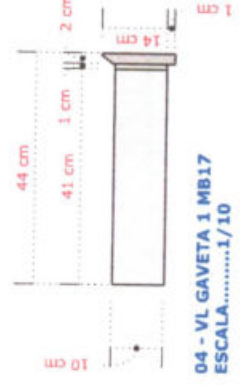
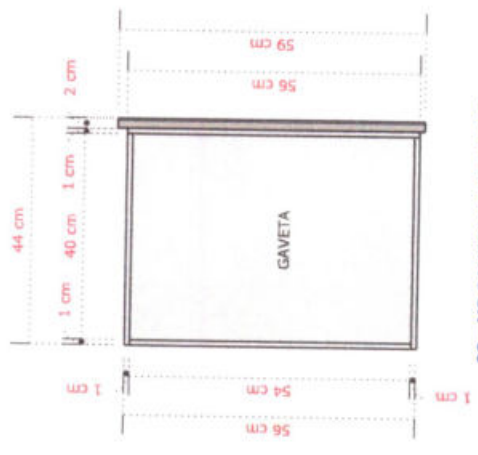
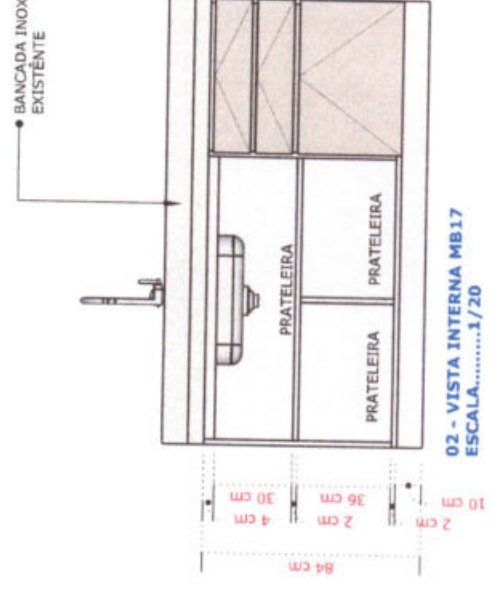
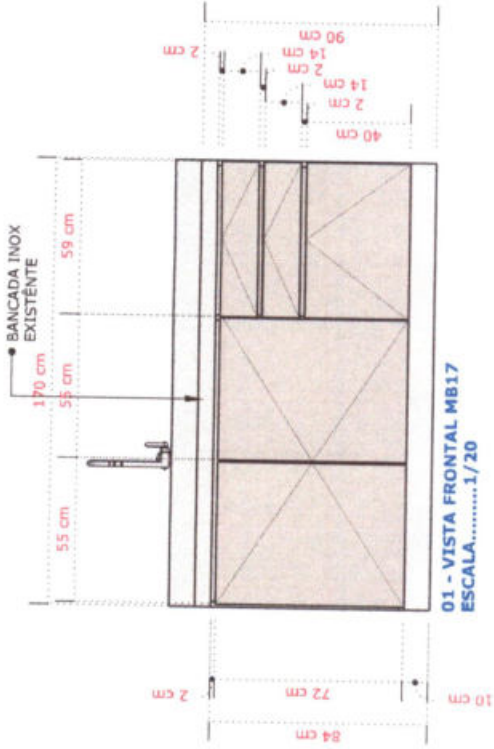

03 - VS GAVETAS 1 E 2 MB17  
ESCALA.....1/10

04 - VL GAVETA 1 MB17  
ESCALA.....1/10

05 - VL GAVETA 2 MB17  
ESCALA.....1/10

06 - DET. PUXADOR CAVA.....1/5  
ESCALA.....1/5



ATENÇÃO: CONFERIR MEDIDAS DOS AMBIENTES ANTES DE EXECUTAR OS MÓVEIS

<b>MOBILIÁRIO CENTRO DE IMAGENS DE HORIZONTE</b>		<b>PRANCHA:</b> <b>26/65</b>	<b>PREFEITURA DE HORIZONTE</b> DE MÃOS DADAS COM VOCE
<b>PROPRIETÁRIO:</b> PREFEITURA MUNICIPAL DE HORIZONTE <b>AUTOR DO PROJETO:</b> ARQ. GEFERSON RAFAEL- CAU Nº A261764-1		<b>CONTEÚDO:</b> 01- VISTA FRONTAL MB17.....1/20 02- VISTA INTERNA MB17.....1/20 03- VS GAVETAS 1 E 2 MB17.....1/20 04- VL GAVETA 1 MB17.....1/10 05- VL GAVETA 2 MB17.....1/10 06- DET. PUXADOR CAVA.....1/5	
<b>LOCAL:</b> HORIZONTE - CE <b>DATA:</b> OUTUBRO - 2023			

*(Handwritten signature)*





02 - PLANTA BAIXA MB18  
ESCALA.....1/10

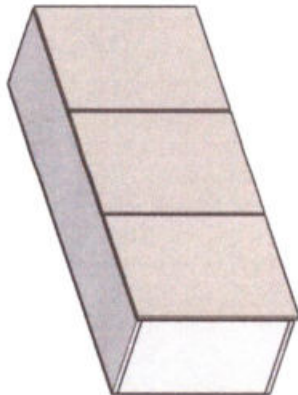

01 - ISOMÉTRICA MB18  
ESCALA.....1/20

FUNDO 6MM  
BRANCO ÁRTICO  
(LINHA TRAMA)



03 - VISTA SUPERIOR MB18  
ESCALA.....1/10

MDF 20MM  
BRANCO ÁRTICO  
(LINHA TRAMA)

ATENÇÃO: CONFERIR MEDIDAS DOS AMBIENTES ANTES DE EXECUTAR OS MÓVEIS



**MOBILIÁRIO CENTRO DE IMAGENS DE HORIZONTE**

PROPRIETÁRIO: PREFEITURA MUNICIPAL DE HORIZONTE

LOCAL: HORIZONTE - CE

**CONTEÚDO:**

- 01- ISOMÉTRICA MB18.....1/20
- 02- PLANTA BAIXA MB18.....1/10
- 03- VISTA SUPERIOR MB18.....1/10

PRANCHA:

27/65



AUTOR DO PROJETO: ARQ. GEFERSON RAFAEL- CAU Nº A261764-1

DATA: OUTUBRO - 2023



**PRANCHA:**  
**28/65**

**CONTEÚDO:**

01- CORTE LATERAL MB18.....	1/10
02- VISTA LATERAL MB18.....	1/10
03- VISTA FRONTAL MB18.....	1/10
04- VISTA INTERNA MB18.....	1/10
05- DET. PUXADOR MB18.....	1/5

**MOBILIÁRIO CENTRO DE IMAGENS DE HORIZONTE**

**PROPRIETÁRIO:** PREFEITURA MUNICIPAL DE HORIZONTE

**LOCAL:** HORIZONTE - CE

**AUTOR DO PROJETO:** ARQ. GEFERSON RAFAEL- CAU Nº A261764-1

**DATA:** OUTUBRO - 2023

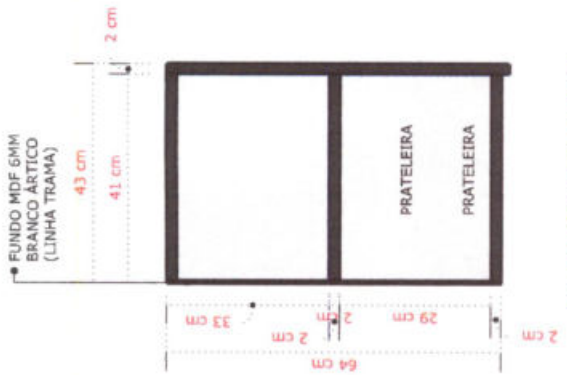
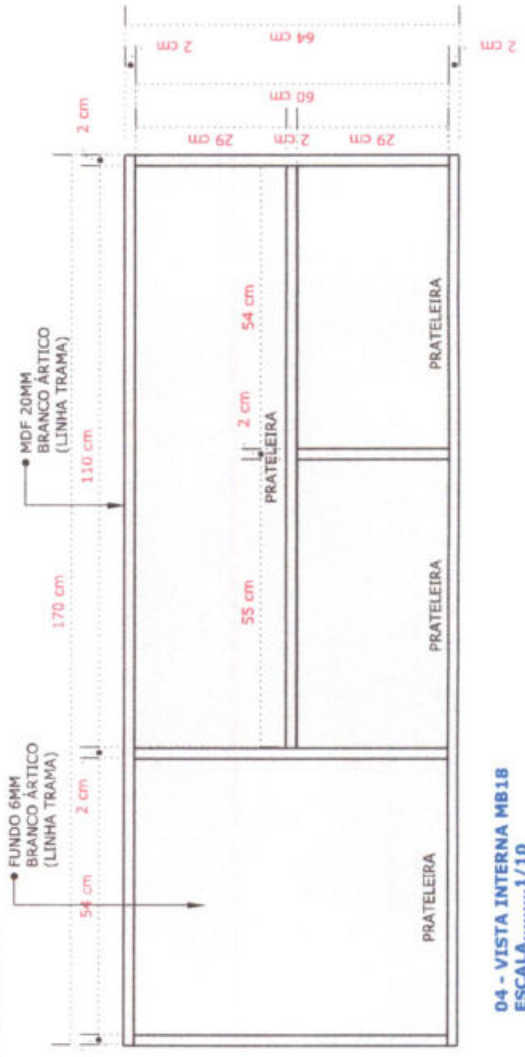
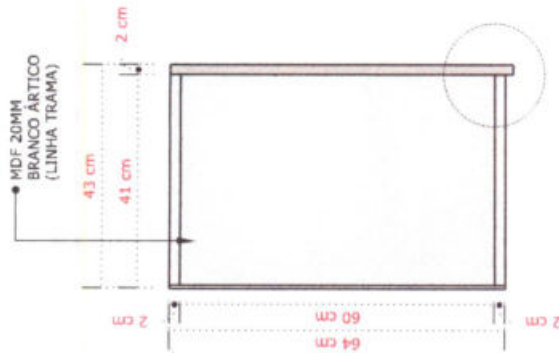
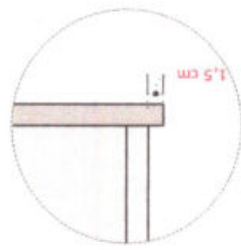
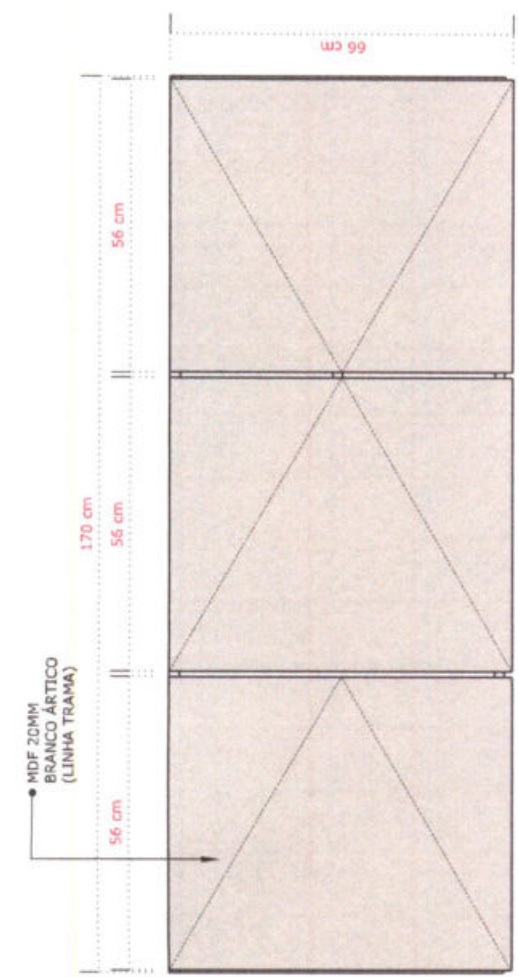

**ATENÇÃO:** CONFERIR MEDIDAS DOS AMBIENTES ANTES DE EXECUTAR OS MÓVEIS



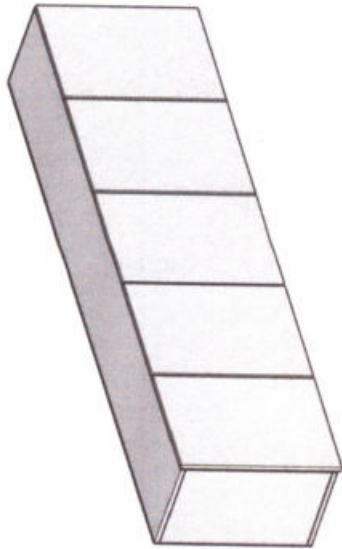

01 - ISOMÉTRICA MB19  
ESCALA.....1/20

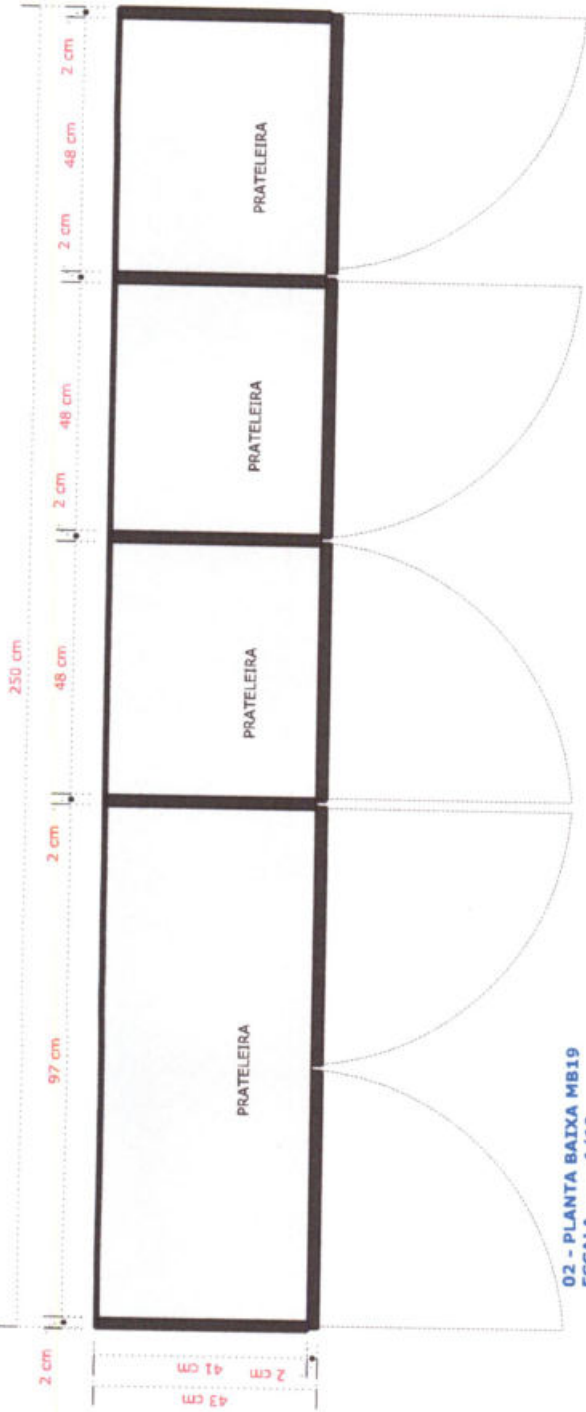

FUNDO MDF 6MM  
BRANCO ÁRTICO  
(LINHA TRAMA)

MDF 20MM  
BRANCO ÁRTICO  
(LINHA TRAMA - ULTRA PREMIUM)



ATENÇÃO: CONFERIR MEDIDAS DOS AMBIENTES ANTES DE EXECUTAR OS MÓVEIS



**MOBILIÁRIO CENTRO DE IMAGENS DE HORIZONTE**

PROPRIETÁRIO: PREFEITURA MUNICIPAL DE HORIZONTE

LOCAL: HORIZONTE - CE

AUTOR DO PROJETO: ARQ. GEFERSON RAFAEL- CAU Nº A261764-1

DATA: OUTUBRO - 2023

**CONTEÚDO:**

- 01- ISOMÉTRICA MB19.....1/20
- 02- PLANTA BAIXA MB19.....1/10
- 03- VISTA SUPERIOR MB19.....1/10

**PRANCHA:**

**29/65**



*(Handwritten signature)*





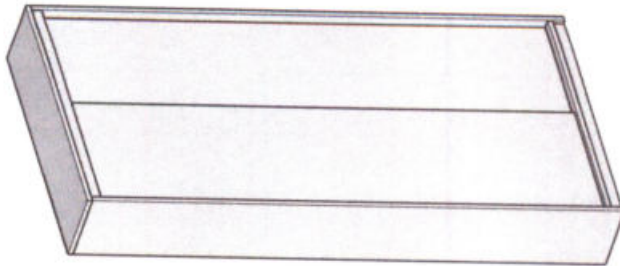

01 - ISOMÉTRICA MB20  
ESCALA.....1/20

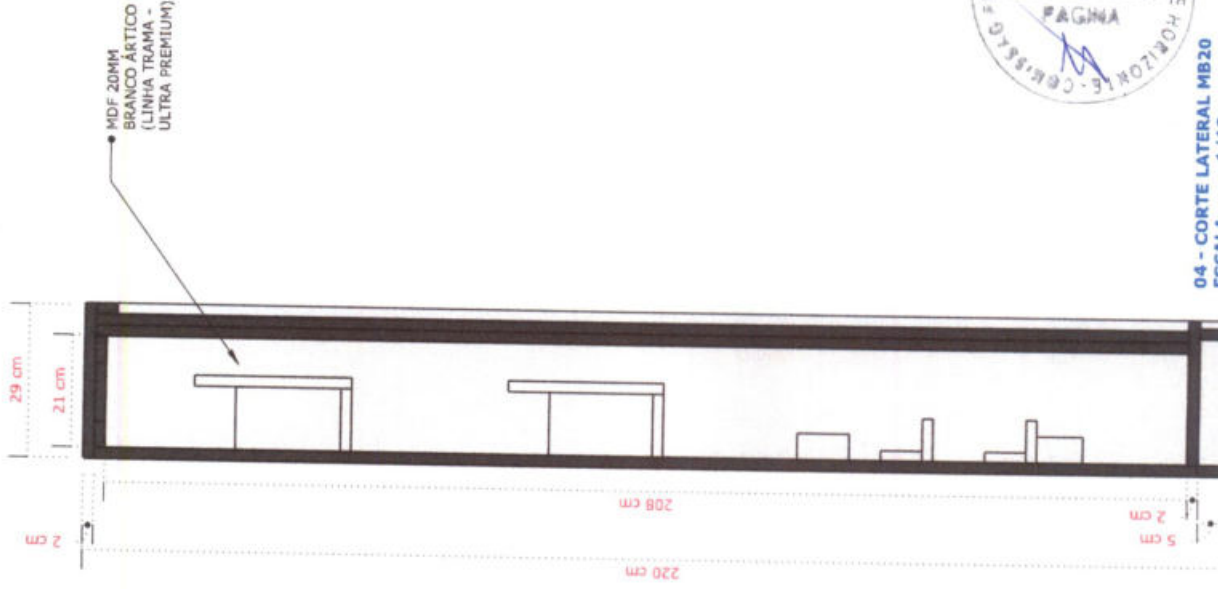
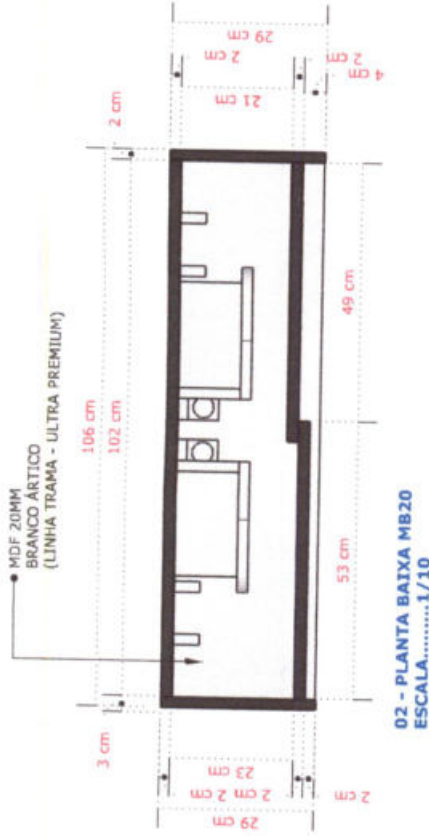

03 - VISTA SUPERIOR MB20  
ESCALA.....1/10



ATENÇÃO: CONFERIR MEDIDAS DOS AMBIENTES ANTES DE EXECUTAR OS MÓVEIS

**MOBILIÁRIO CENTRO DE IMAGENS DE HORIZONTE**

PROPRIETÁRIO: PREFEITURA MUNICIPAL DE HORIZONTE

LOCAL: HORIZONTE - CE

AUTOR DO PROJETO: ARQ. GEFERSON RAFAEL- CAU Nº A261764-1

DATA: OUTUBRO - 2023

**CONTEÚDO:**

- 01- ISOMÉTRICA MB20.....1/20
- 02- PLANTA BAIXA MB20.....1/10
- 03- VISTA SUPERIOR MB20.....1/10
- 04- CORTE LATERAL MB20.....1/10

**PRANCHA:**

**31/65**







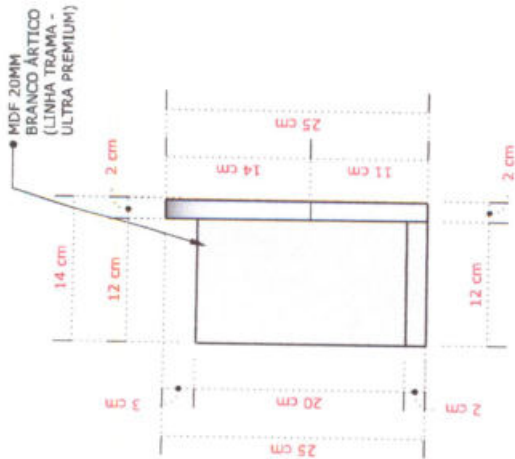

01 - DET. SUPERIOR D1  
ESCALA.....1/5

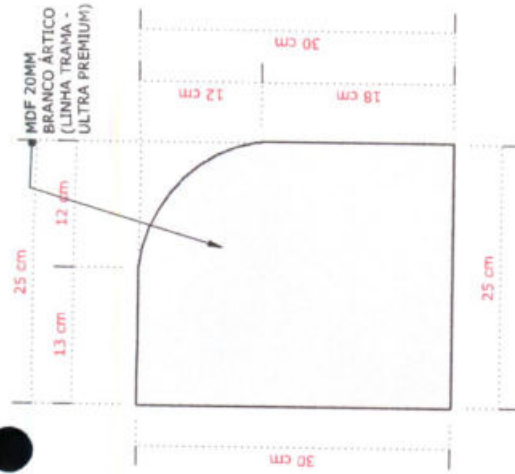

02 - DET. FRONTAL D1  
ESCALA.....1/5

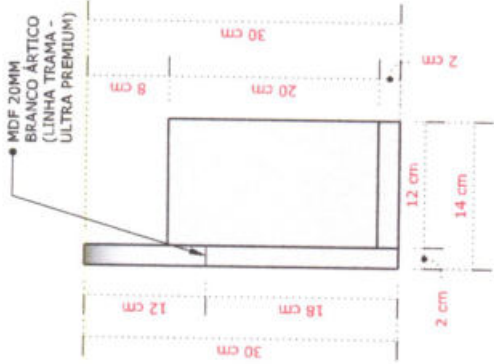

03 - DET. LATERAL D1  
ESCALA.....1/5

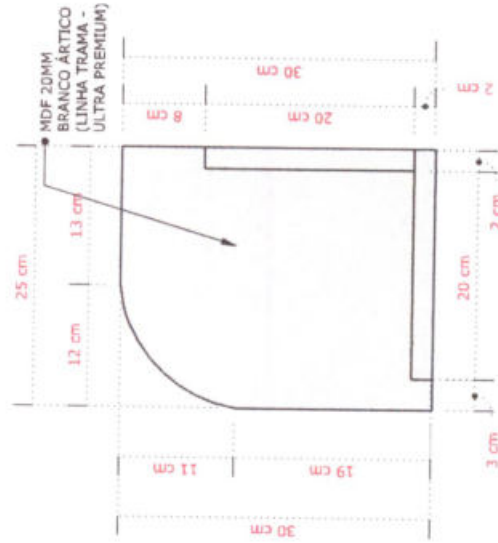

04 - DET. POSTERIOR D1  
ESCALA.....1/5

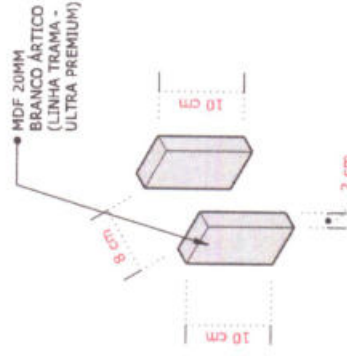

05 - DET. ISOMÉTRICO D2  
ESCALA.....1/5

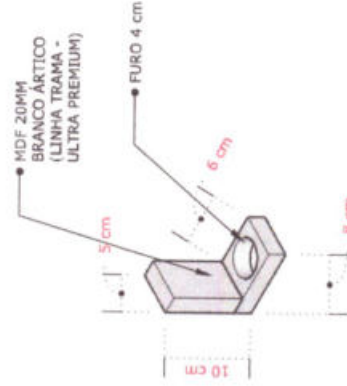

06 - DET. ISOMÉTRICO D3  
ESCALA.....1/5



**MOBILIÁRIO CENTRO DE IMAGENS DE HORIZONTE**

PROPRIETÁRIO: PREFEITURA MUNICIPAL DE HORIZONTE

AUTOR DO PROJETO: ARQ. GEFERSON RAFAEL- CAU Nº A261764-1

LOCAL: HORIZONTE - CE

DATA: OUTUBRO - 2023

- CONTEÚDO:**
- 01- DET. SUPERIOR D1.....1/5
  - 02- DET. FRONTAL D1.....1/5
  - 03- DET. LATERAL D1.....1/5
  - 04- DET. POSTERIOR.....1/5
  - 05- DET. ISOMÉTRICO D2.....1/5
  - 06- DET. ISOMÉTRICO D3.....1/5

PRANCHA:

**33 / 65**



*(Handwritten signature)*

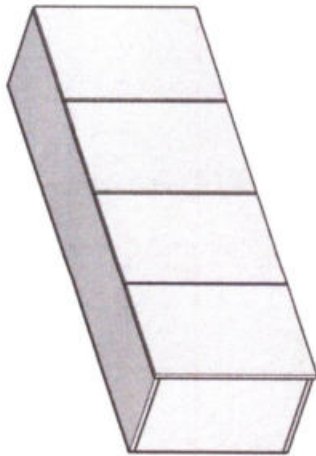

01 - ISOMÉTRICA MB21  
ESCALA.....1/20

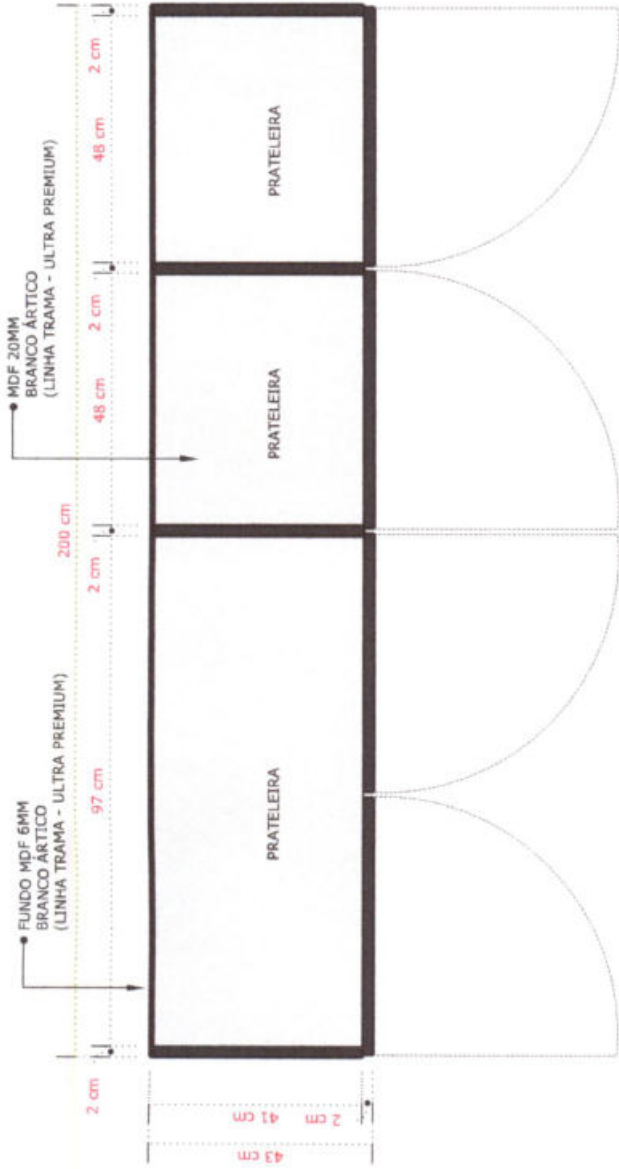

02 - PLANTA BAIXA MB21  
ESCALA.....1/10

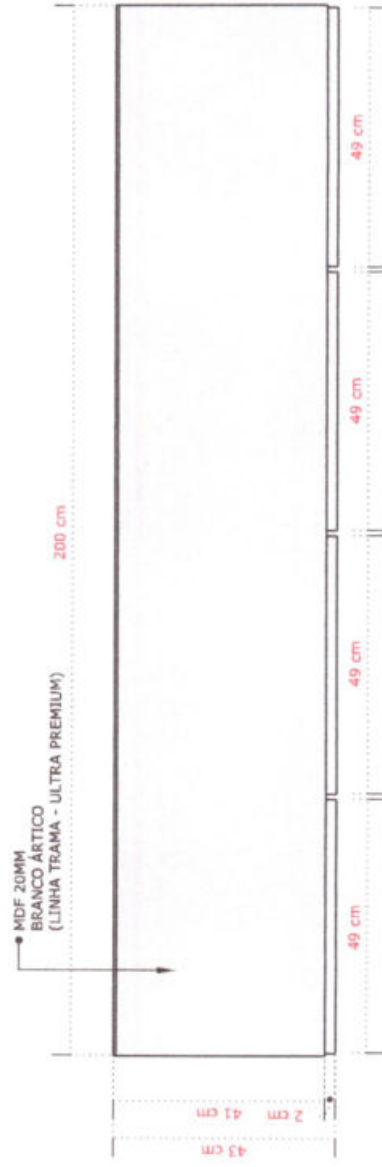

03 - VISTA SUPERIOR MB21  
ESCALA.....1/10

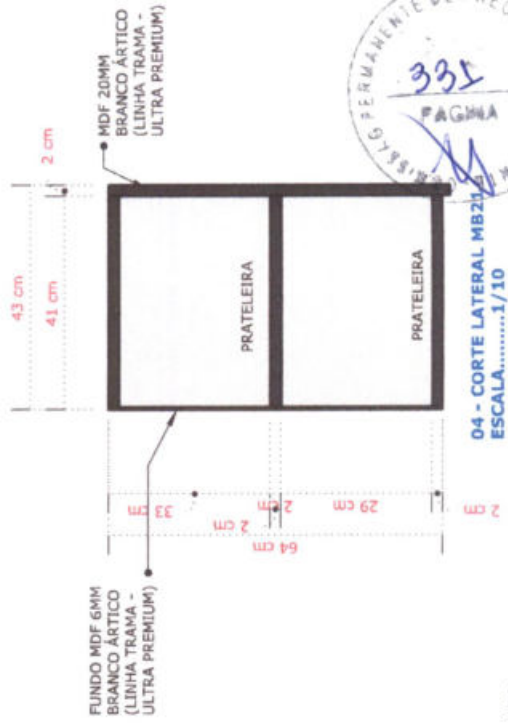

04 - CORTE LATERAL MB21  
ESCALA.....1/10

ATENÇÃO: CONFERIR MEDIDAS DOS AMBIENTES ANTES DE EXECUTAR OS MÓVEIS



**MOBILIÁRIO CENTRO DE IMAGENS DE HORIZONTE**

PROPRIETÁRIO: PREFEITURA MUNICIPAL DE HORIZONTE

AUTOR DO PROJETO: ARQ. GEFERSON RAFAEL- CAU Nº A261764-1

LOCAL: HORIZONTE - CE

DATA: OUTUBRO - 2023

**CONTEÚDO:**

- 01- ISOMÉTRICA MB21.....1/20
- 02- PLANTA BAIXA MB21.....1/10
- 03- VISTA SUPERIOR MB21.....1/10
- 04- CORTE LATERAL MB21.....1/10

**PRANCHA:**

**34/65**



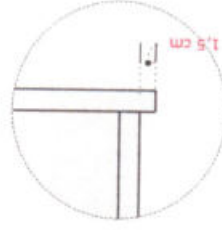
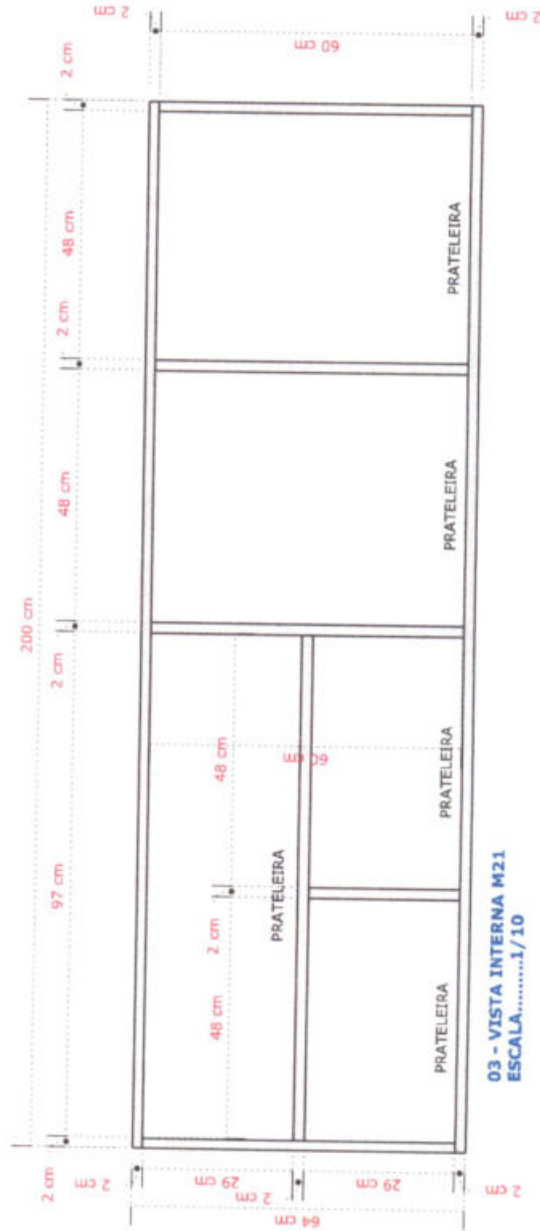
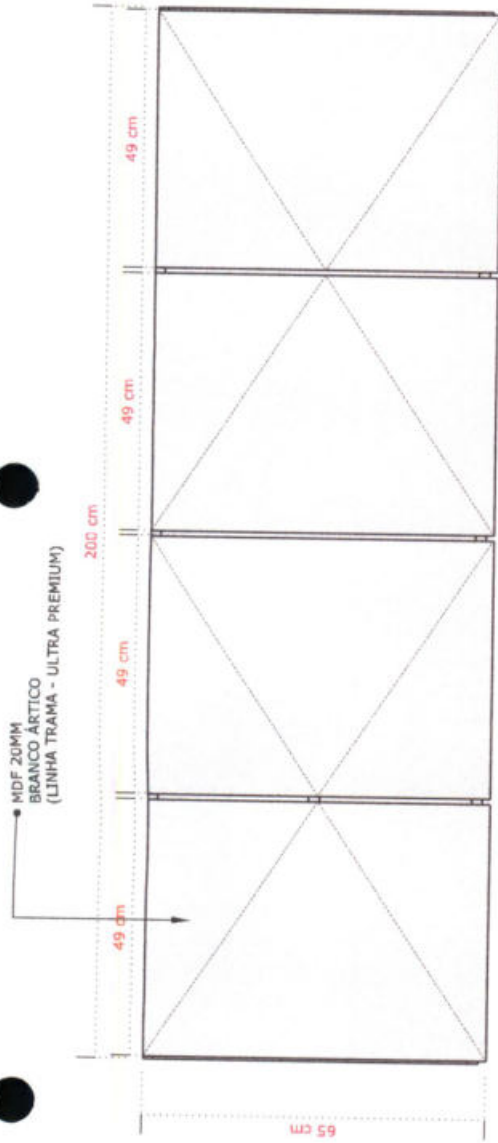
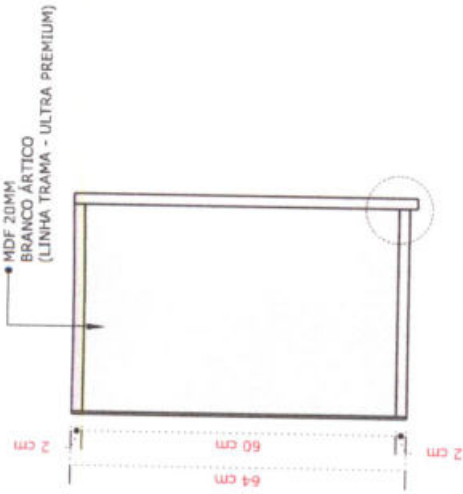

ATENÇÃO: CONFERIR MEDIDAS DOS AMBIENTES ANTES DE EXECUTAR OS MÓVEIS

**MOBILIÁRIO CENTRO DE IMAGENS DE HORIZONTE**

PROPRIETÁRIO: PREFEITURA MUNICIPAL DE HORIZONTE  
AUTOR DO PROJETO: ARQ. GEFERSON RAFAEL- CAU Nº A261.764-1

LOCAL: HORIZONTE - CE  
DATA: OUTUBRO - 2023

**CONTEÚDO:**

- 01- VISTA LATERAL MB21.....1/10
- 02- VISTA FRONTAL MB21.....1/10
- 03- VISTA INTERNA MB21.....1/10
- 04- DET. PUXADOR MB21.....1/10

**PRANCHA:**

**35 / 65**



*[Handwritten signature]*





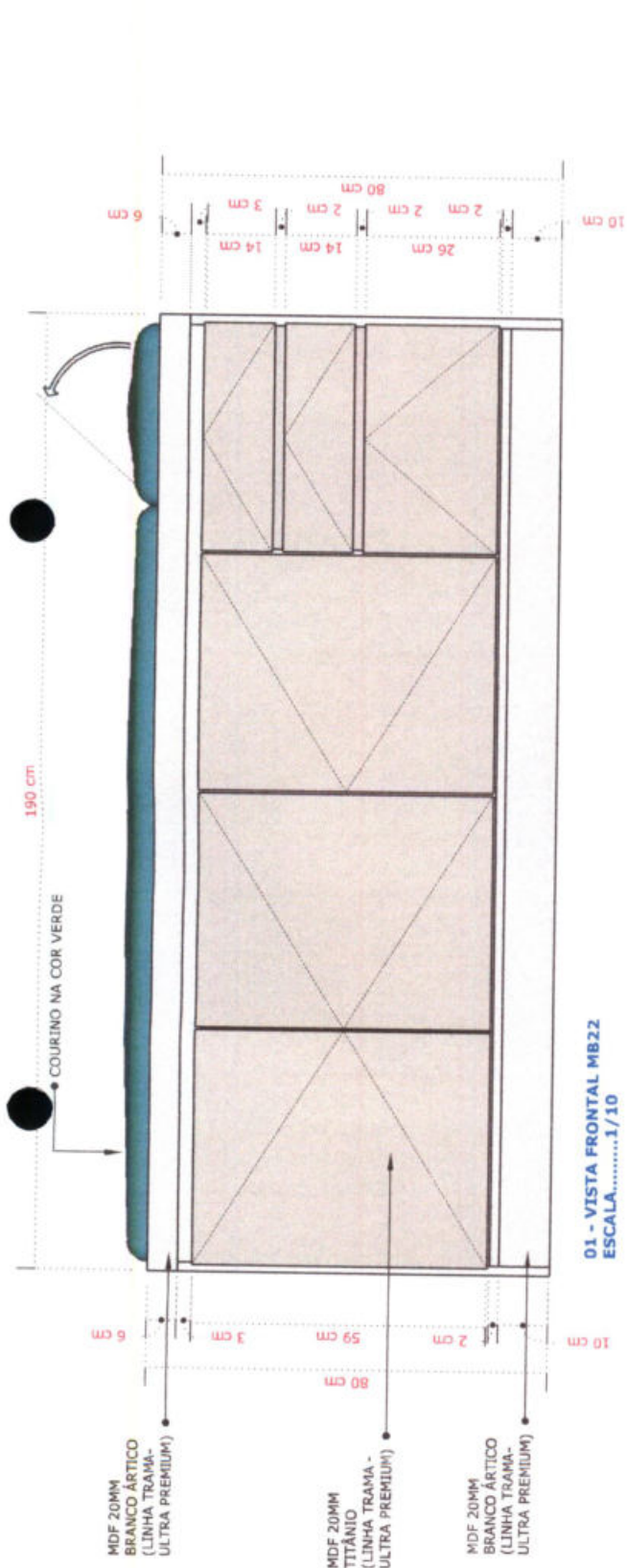

01 - VISTA FRONTAL MB22  
ESCALA.....1/10

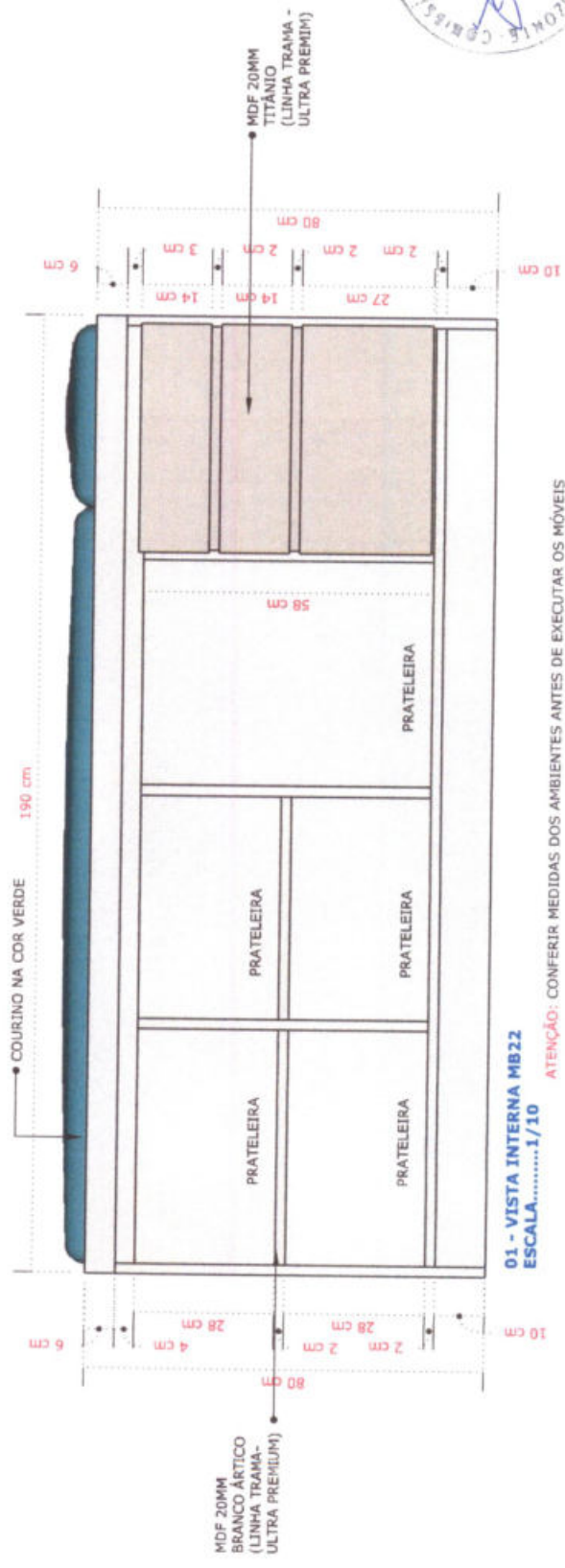

01 - VISTA INTERNA MB22  
ESCALA.....1/10

ATENÇÃO: CONFERIR MEDIDAS DOS AMBIENTES ANTES DE EXECUTAR OS MÓVEIS



<b>MOBILIÁRIO CENTRO DE IMAGENS DE HORIZONTE</b> PROPRIETÁRIO: PREFEITURA MUNICIPAL DE HORIZONTE AUTOR DO PROJETO: ARQ. GEFERSON RAFAEL - CAU Nº A261764-1		<b>CONTEÚDO:</b> 01- VISTA FRONTAL MB22.....1/10 02- VISTA INTERNA.....1/10	<b>PRANCHA:</b> <b>37 / 65</b>	
--	--	---	-----------------------------------	--

*(Handwritten signature)*

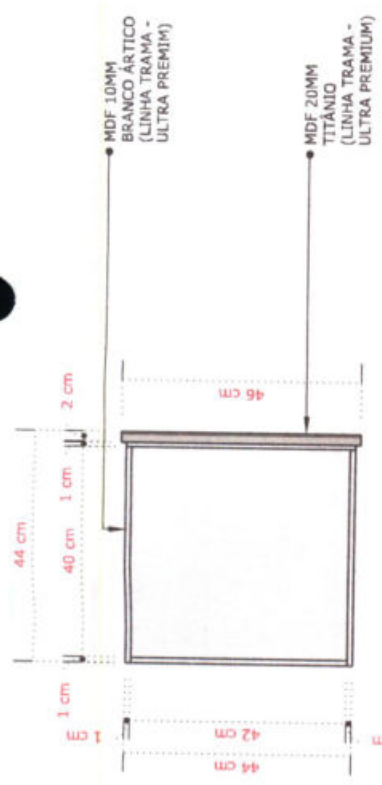

02 - DET. GAVETA 1 E 2 VS MB22  
ESCALA.....1/10

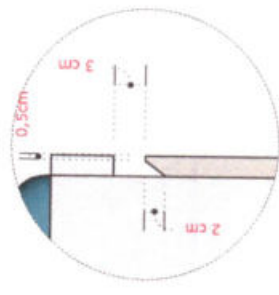

05 - DET. PUXADOR CAVA MB22  
ESCALA.....1/10

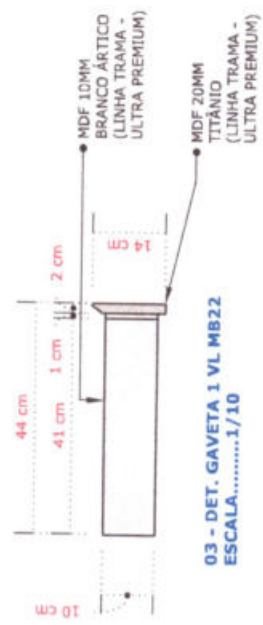

03 - DET. GAVETA 1 VL MB22  
ESCALA.....1/10

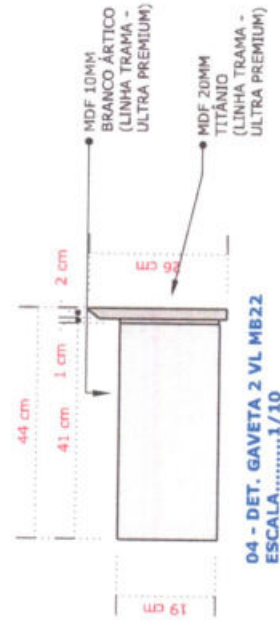

04 - DET. GAVETA 2 VL MB22  
ESCALA.....1/10

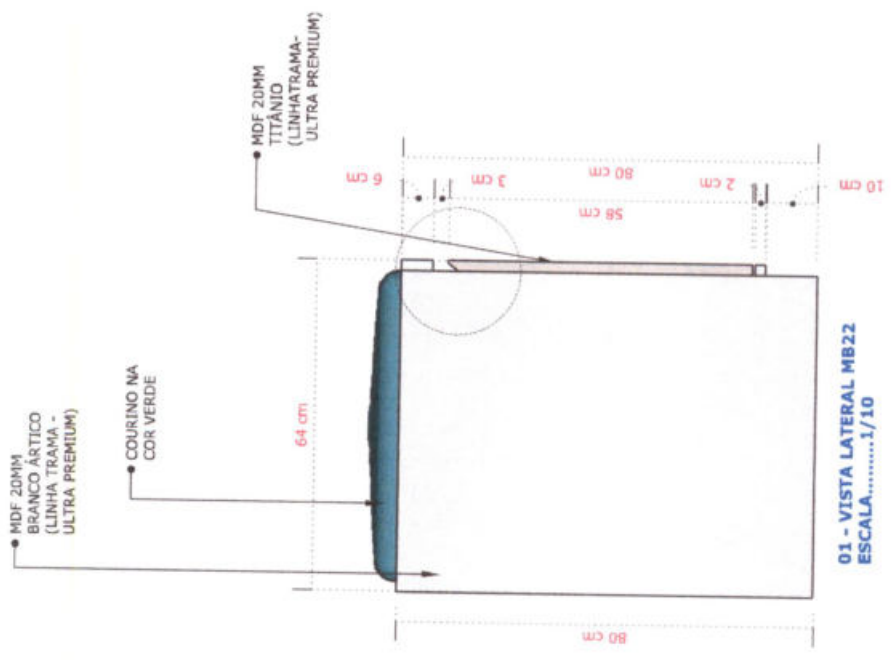

01 - VISTA LATERAL MB22  
ESCALA.....1/10

**MOBILIÁRIO CENTRO DE IMAGENS DE HORIZONTE**

PROPRIETÁRIO: PREFEITURA MUNICIPAL DE HORIZONTE LOCAL: HORIZONTE - CE  
 AUTOR DO PROJETO: ARQ. GEFERSON RAFAEL- CAU Nº A261764-1 DATA: OUTUBRO - 2023

**CONTEÚDO:**

- 01- VISTA LATERAL MB22.....1/10
- 02- DET. GAVETA 1 E 2 VS MB22.....1/10
- 03- DET. GAVETA 1 VL MB22.....1/10
- 04- DET. GAVETA 2 VL MB22.....1/10
- 05- DET. PUXADOR CAVA MB22.....1/10

**PRANCHA:**

**38/65**



Handwritten signature or initials in a circle.



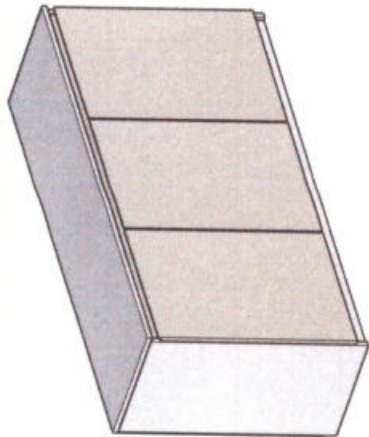

01 - ISOMÉTRICA MB23  
ESCALA.....1/20

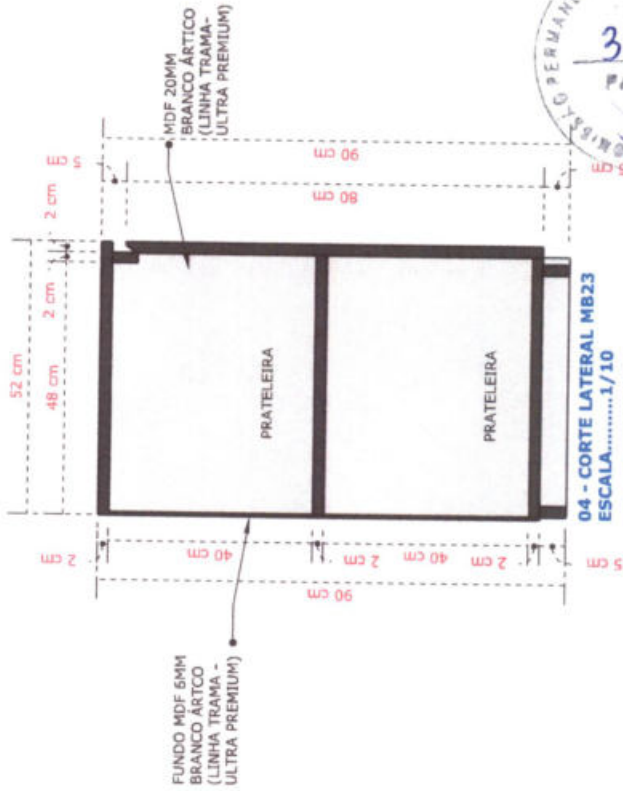
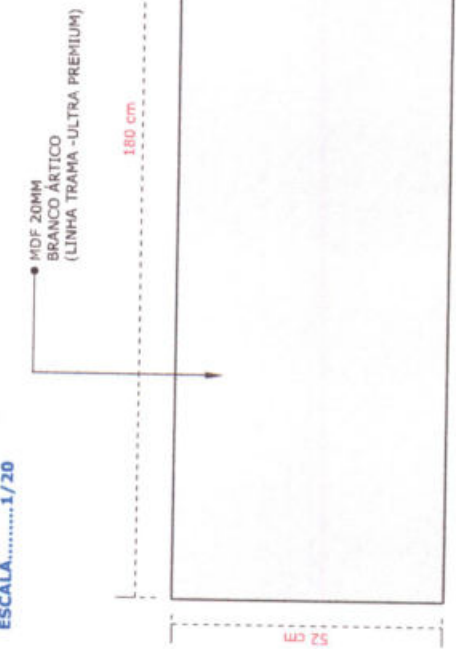
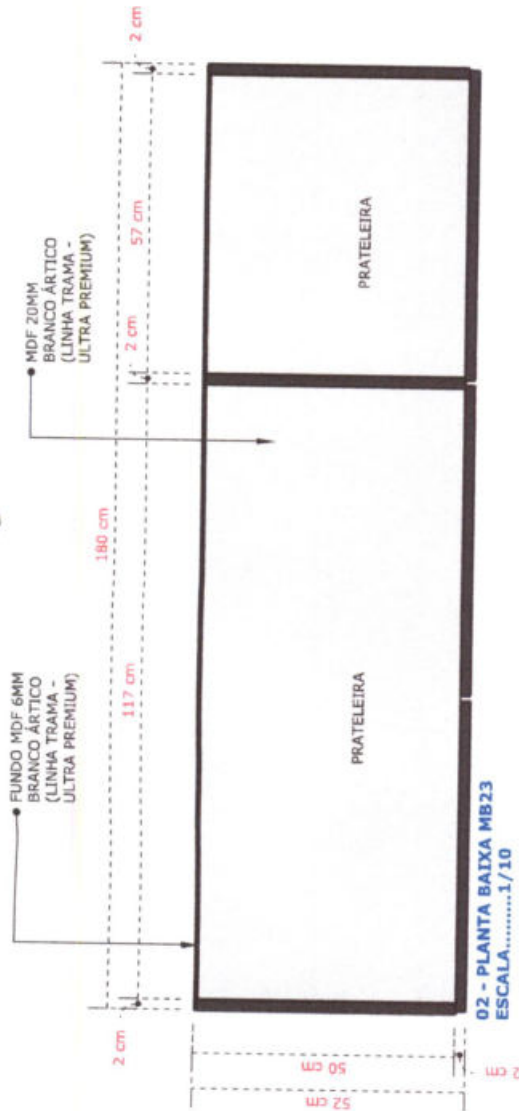

ATENÇÃO: CONFERIR MEDIDAS DOS AMBIENTES ANTES DE EXECUTAR OS MÓVEIS

<b>MOBILIÁRIO CENTRO DE IMAGENS DE HORIZONTE</b> PROPRIETÁRIO: PREFEITURA MUNICIPAL DE HORIZONTE AUTOR DO PROJETO: ARQ. GEFERSON RAFAEL- CAU Nº A261764-1		LOCAL: HORIZONTE - CE DATA: OUTUBRO - 2023	<b>CONTEÚDO:</b> 01- ISOMÉTRICA MB23.....1/20 02- PLANTA BAIXA MB23.....1/10 03- VISTA SUPERIOR MB23.....1/10 04- CORTE LATERAL MB23.....1/10	<b>PRANCHA:</b> <b>39 / 65</b>	PREFEITURA DE <b>HORIZONTE</b> DE MÃOS DADAS COM VOCE
---	--	---	---	-----------------------------------	---

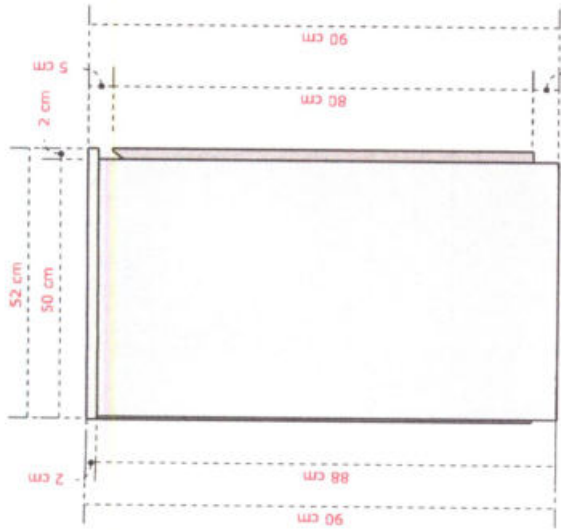

01 - VISTA INTERNA MB23  
ESCALA.....1/10

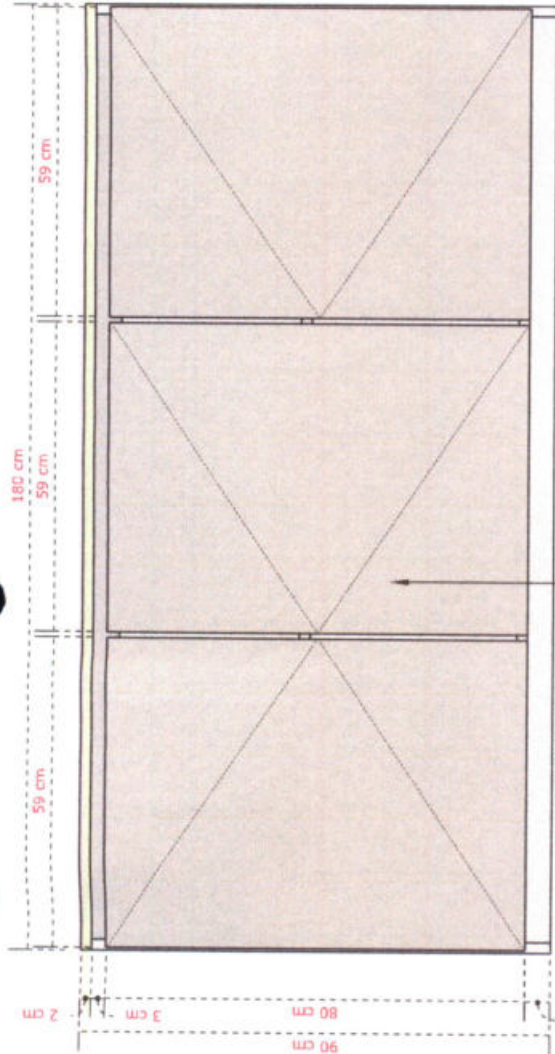

02 - VISTA FRONTAL MB23  
ESCALA.....1/10

MDF 20MM  
TITÂNIO  
(LINHA TRAMA -  
ULTRA PREMIUM)

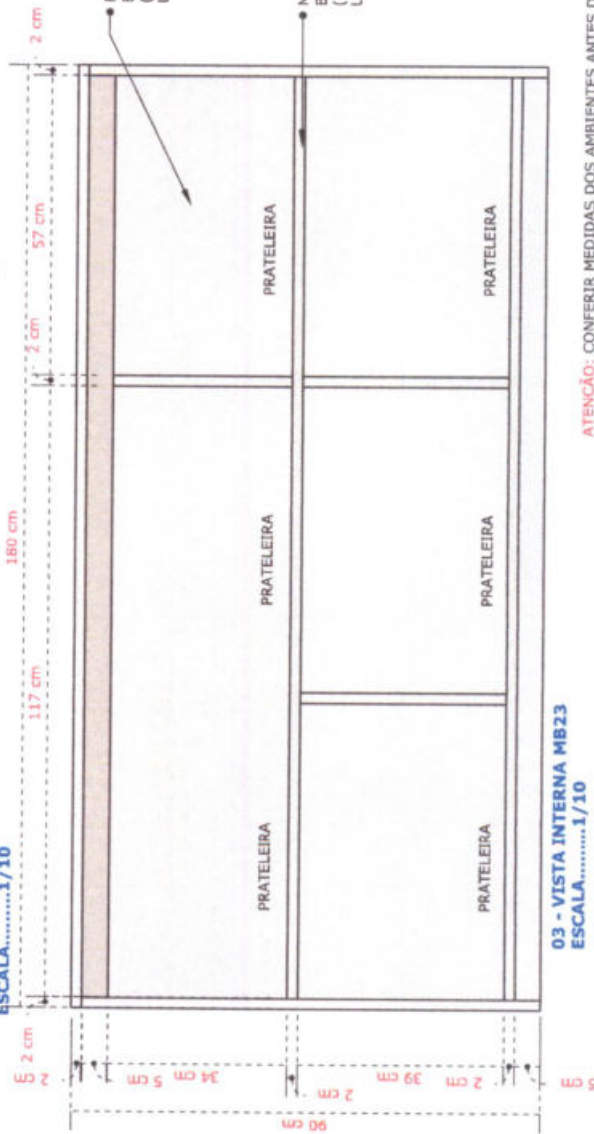

03 - VISTA INTERNA MB23  
ESCALA.....1/10

FUNDO MDF 6MM  
BRANCO ÁRTICO  
(LINHA TRAMA -  
ULTRA PREMIUM)

MDF 20MM  
BRANCO ÁRTICO  
(LINHA TRAMA -  
ULTRA PREMIUM)

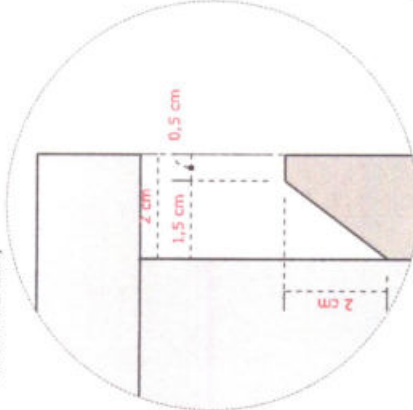

04 - DET. PUXADOR CAVA MB23  
ESCALA.....1/1

ATENÇÃO: CONFERIR MEDIDAS DOS AMBIENTES ANTES DE EXECUTAR OS MÓVEIS



**MOBILIÁRIO CENTRO DE IMAGENS DE HORIZONTE**

PROPRIETÁRIO: PREFEITURA MUNICIPAL DE HORIZONTE

LOCAL: HORIZONTE - CE

AUTOR DO PROJETO: ARQ. GEFERSON RAFAEL- CAU Nº A261764-1

DATA: OUTUBRO - 2023

**CONTEÚDO:**

- 01- VISTA LATERAL MB23.....1/10
- 02- VISTA FRONTAL MB23.....1/10
- 03- VISTA INTERNA MB23.....1/10
- 04- DET. PUXADOR CAVA MB23.....1/1

PRANCHA:

**40 / 65**



*(Handwritten signature)*

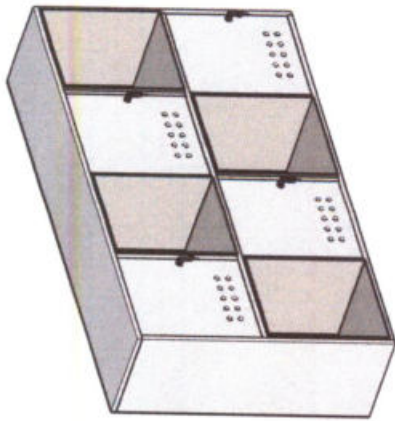

01 - ISOMÉTRICA MB24  
ESCALA.....1/20

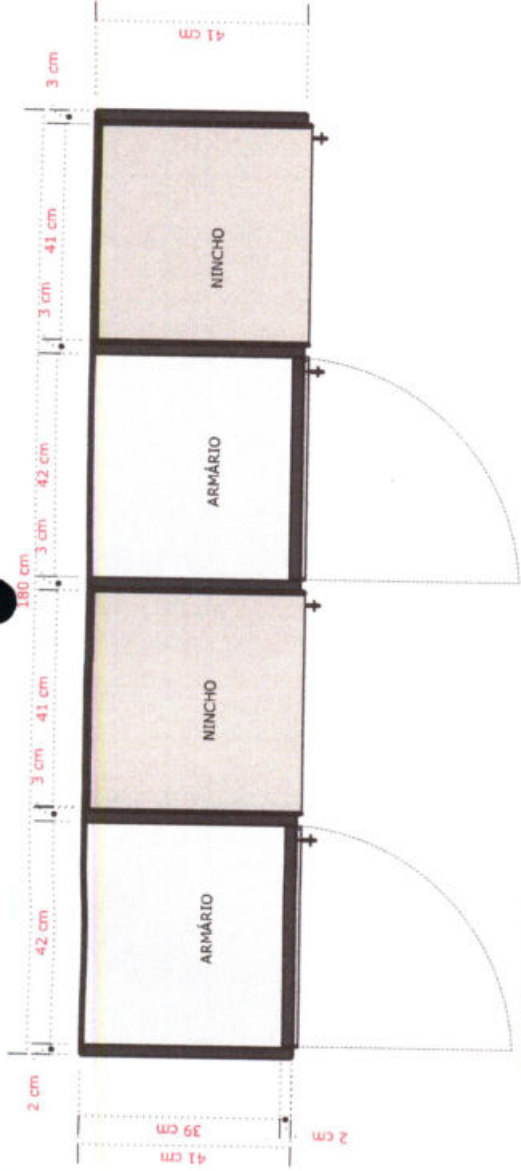

02- PLANTA BAIXA MB24  
ESCALA.....1/10

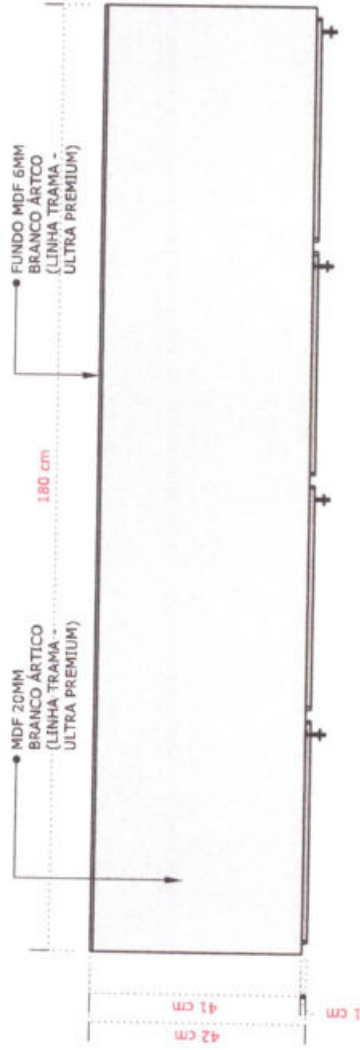

03- VISTA SUPERIOR MB24  
ESCALA.....1/10

ATENÇÃO: CONFERIR MEDIDAS DOS AMBIENTES ANTES DE EXECUTAR OS MÓVEIS



**MOBILIÁRIO CENTRO DE IMAGENS DE HORIZONTE**

PROPRIETÁRIO: PREFEITURA MUNICIPAL DE HORIZONTE

AUTOR DO PROJETO: ARQ. GEFERSON RAFAEL- CAU Nº A261764-1

LOCAL: HORIZONTE - CE

DATA: OUTUBRO - 2023

**CONTEÚDO:**

- 01- ISOMÉTRICA MB24.....1/10
- 02- PLANTA BAIXA MB24.....1/10
- 03- VISTA SUPERIOR MB24.....1/10

PRANCHA:

**41/65**





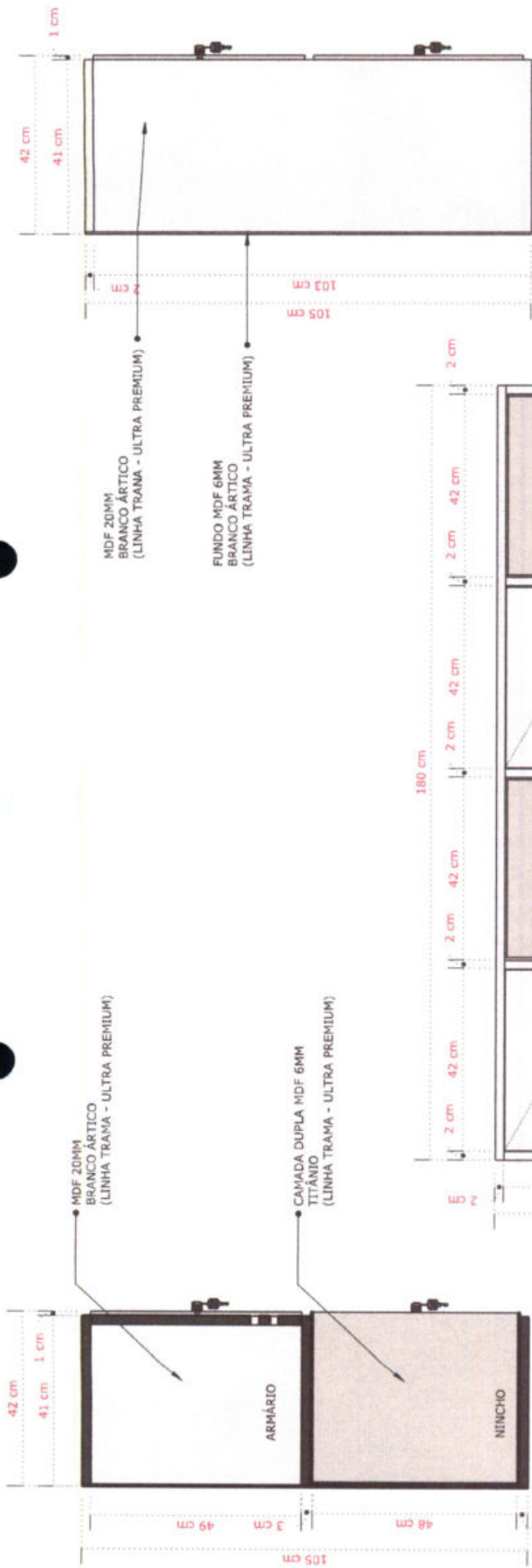

ATENÇÃO: CONFERIR MEDIDAS DOS AMBIENTES ANTES DE EXECUTAR OS MÓVEIS

**MOBILIÁRIO CENTRO DE IMAGENS DE HORIZONTE**

PROPRIETÁRIO: PREFEITURA MUNICIPAL DE HORIZONTE

AUTOR DO PROJETO: ARQ. GEFERSON RAFAEL- CAU Nº A261764-1

LOCAL: HORIZONTE - CE

DATA: OUTUBRO - 2023

**CONTEÚDO:**

- 01- CORTE LATERAL MB24.....1/10
- 02- VISTA LATERAL MB24.....1/10
- 03- VISTA FRONTAL MB24.....1/10

PRANCHA:

**42/65**



*(Handwritten signature)*

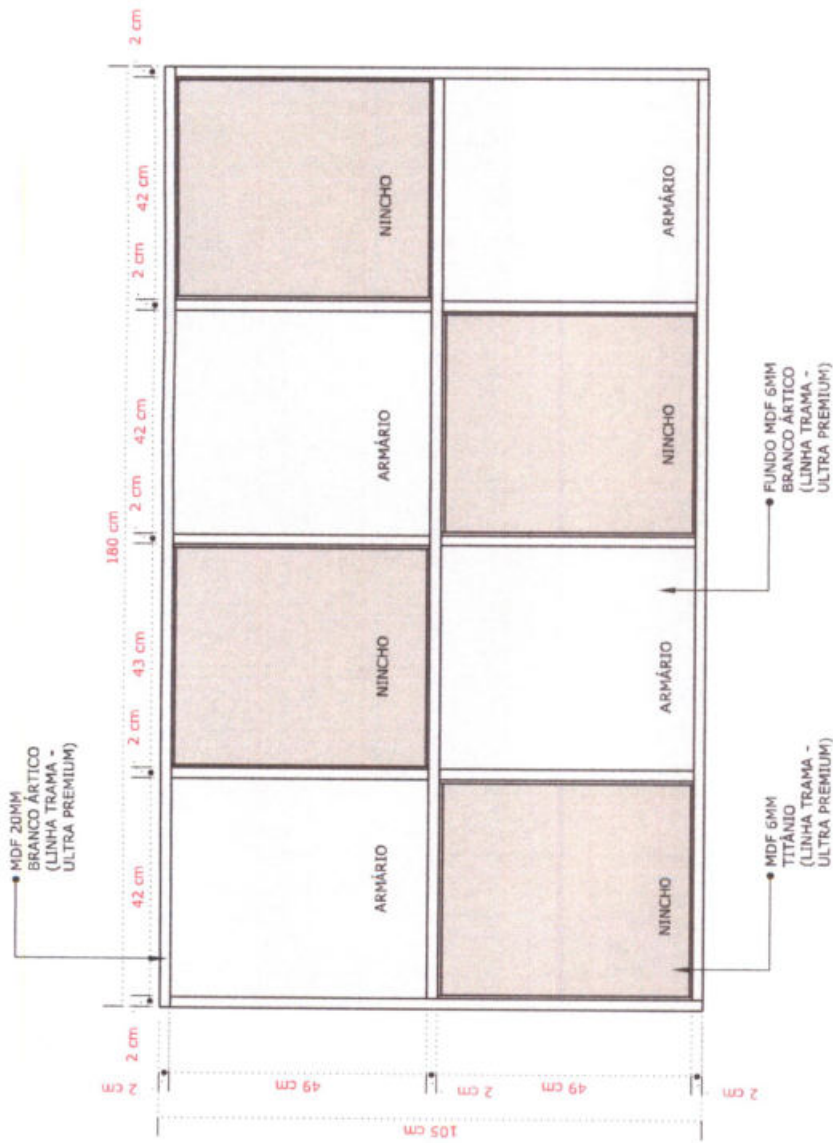

01 - VISTA INTERNA  
ESCALA.....1/10

FECHADURA PARA MÓVEIS  
DE AÇO 19mm X 20mm

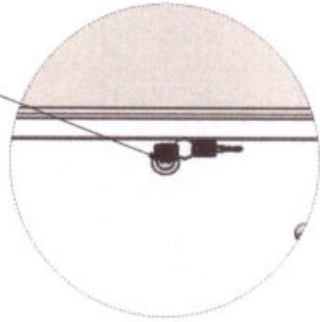

02 - DET. FECHADURA  
ESCALA.....1/5



<b>MOBILIÁRIO CENTRO DE IMAGENS DE HORIZONTE</b>	
PROPRIETÁRIO: PREFEITURA MUNICIPAL DE HORIZONTE AUTOR DO PROJETO: ARQ. GEFERSON RAFAEL- CAU Nº A261764-1	LOCAL: HORIZONTE - CE DATA: OUTUBRO - 2023
<b>CONTEÚDO:</b> 01- VISTA INTERNA.....1/10 02- DET. FECHADURA.....1/5	<b>PRANCHA:</b> <b>43/65</b>

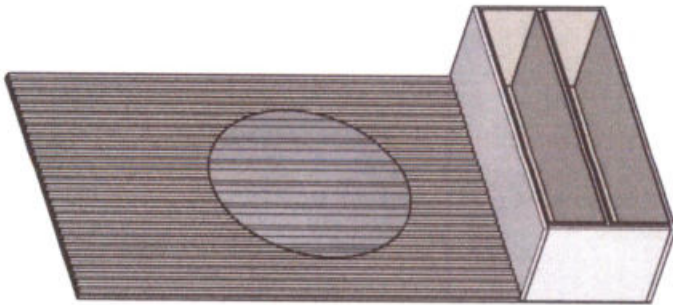

01 - ISOMÉTRICA MB25  
ESCALA.....1/20



02 - VISTA SUPERIOR MB25  
ESCALA.....1/10

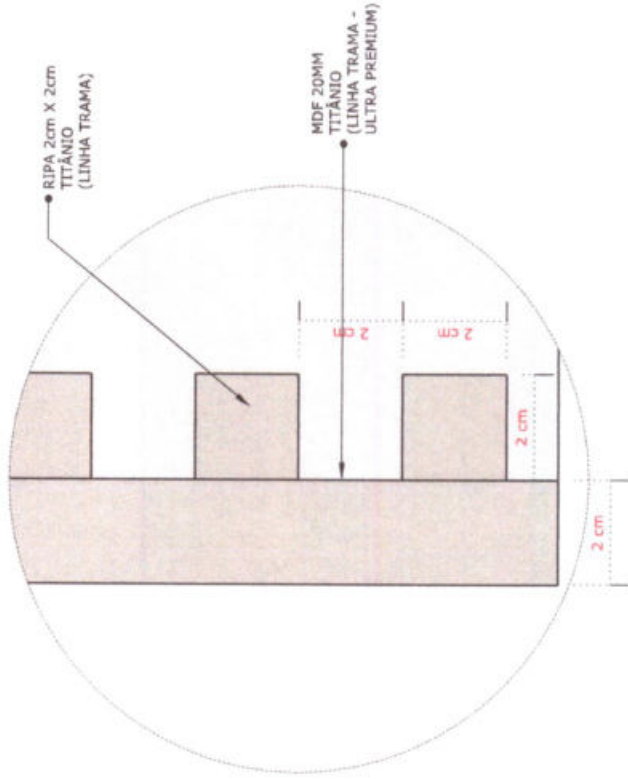

03 - DET. RIPADO MB25  
ESCALA.....1/1

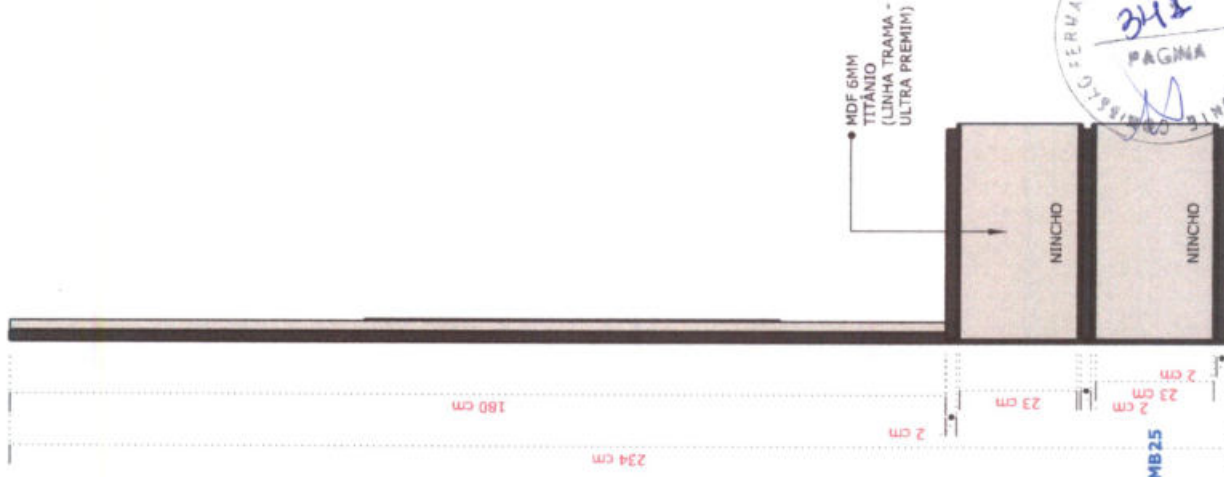

04 - CORTE LATERAL MB25  
ESCALA.....1/10

ATENÇÃO: CONFERIR MEDIDAS DOS AMBIENTES ANTES DE EXECUTAR OS MÓVEIS



**MOBILIÁRIO CENTRO DE IMAGENS DE HORIZONTE**

PROPRIETÁRIO: PREFEITURA MUNICIPAL DE HORIZONTE

AUTOR DO PROJETO: ARQ. GEFERSON RAFAEL- CAU Nº A261764-1

LOCAL: HORIZONTE - CE

DATA: OUTUBRO - 2023

**CONTEÚDO:**

- 01- ISOMÉTRICA MB25.....1/20
- 02- VISTA SUPERIOR MB25.....1/10
- 03- DET. RIPADO MB25.....1/1
- 04- CORTE LATERAL MB25.....1/10

PRANCHA:

44/65



*[Handwritten signature]*



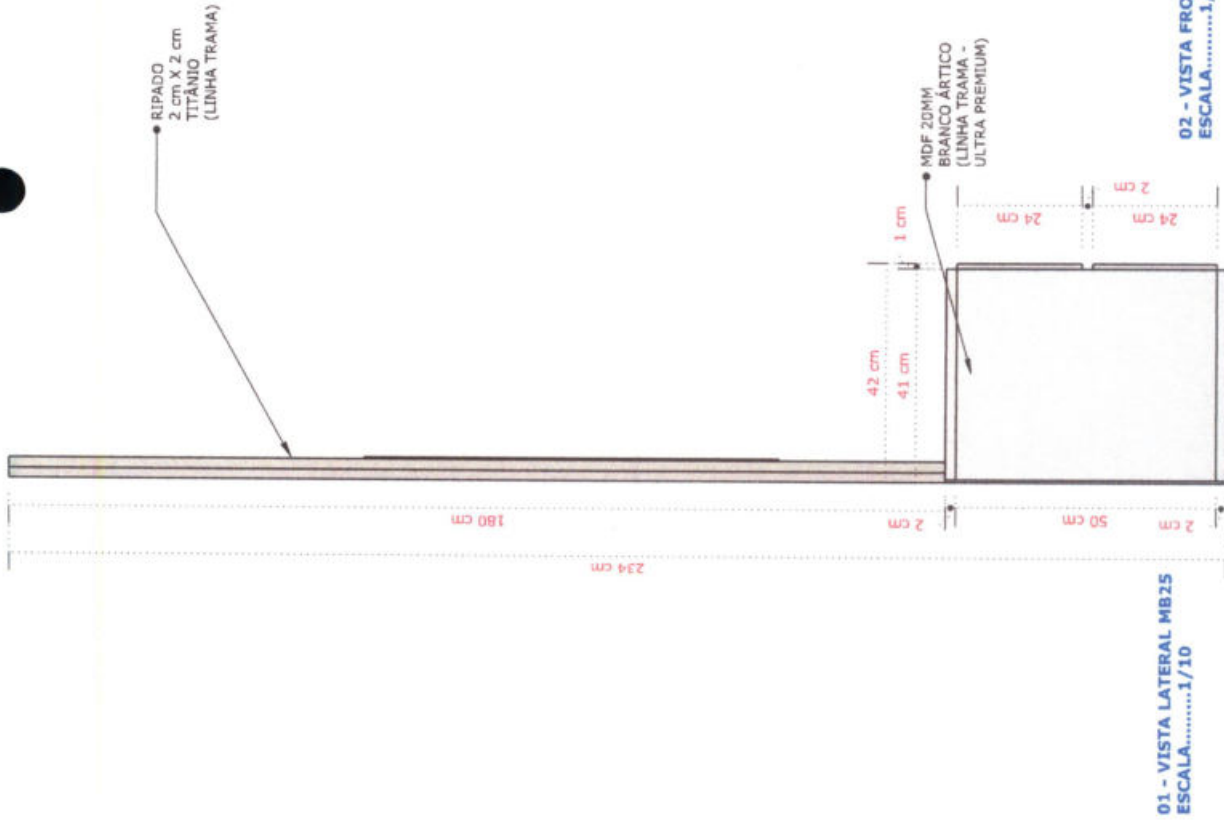

01 - VISTA LATERAL MB25  
ESCALA.....1/10

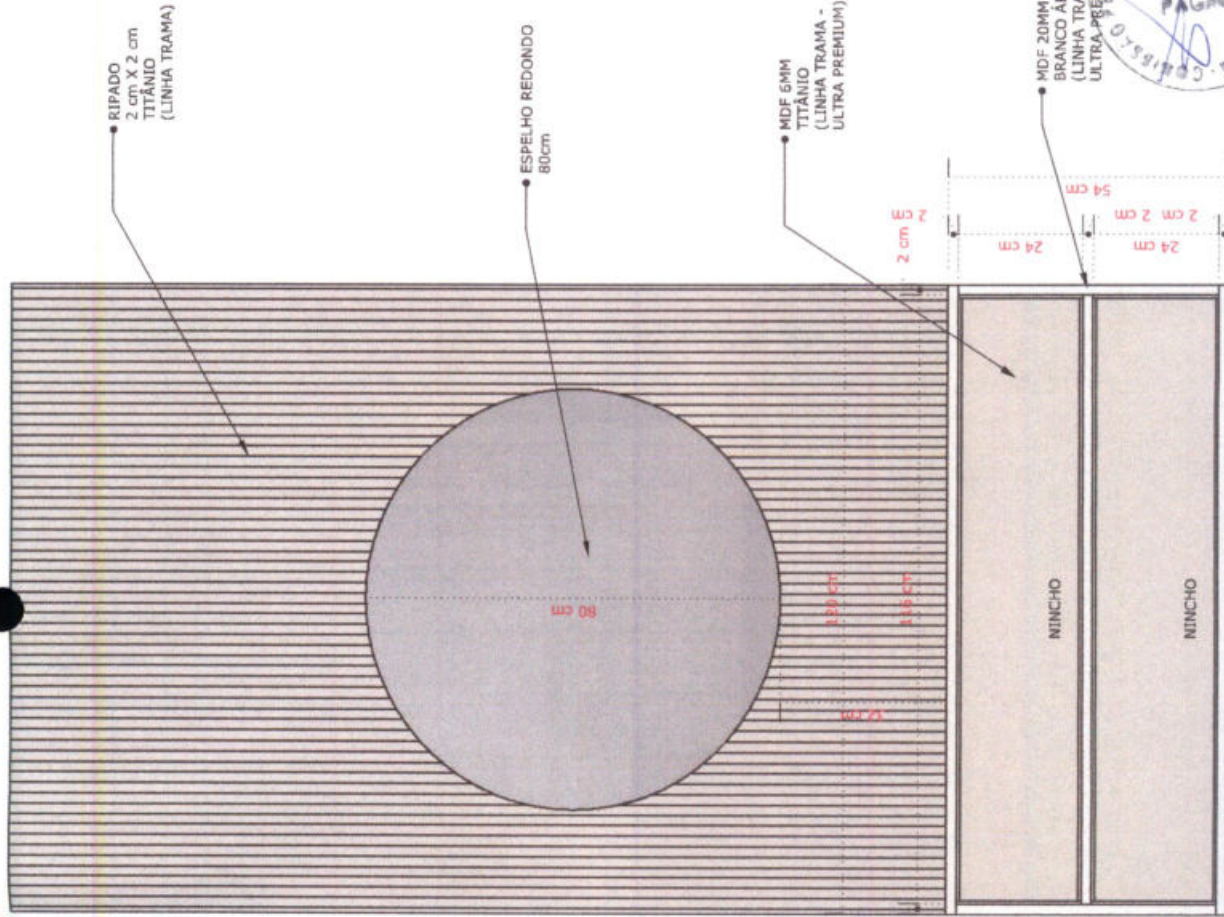

02 - VISTA FRONTAL MB25  
ESCALA.....1/10

ATENÇÃO: CONFERIR MEDIDAS DOS AMBIENTES ANTES DE EXECUTAR OS MÓVEIS

**MOBILIÁRIO CENTRO DE IMAGENS DE HORIZONTE**

PROPRIETÁRIO: PREFEITURA MUNICIPAL DE HORIZONTE

AUTOR DO PROJETO: ARQ. GEFERSON RAFAEL- CAU Nº A261764-1

LOCAL: HORIZONTE - CE

DATA: OUTUBRO - 2023

**CONTEÚDO:**

- 01- VISTA LATERAL MB25.....1/10
- 02- VISTA FRONTAL MB25.....1/10

**PRANCHA:**

**45/65**



*(Handwritten mark)*

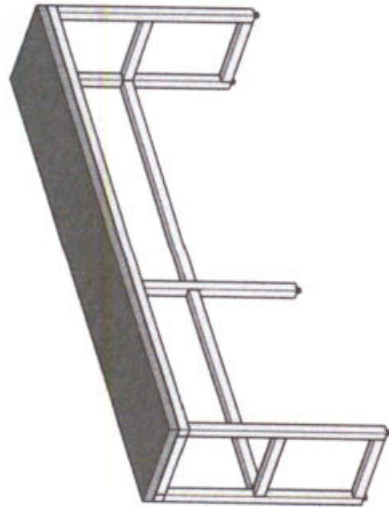

01 - ISOMÉTRICA MB26  
ESCALA.....1/10

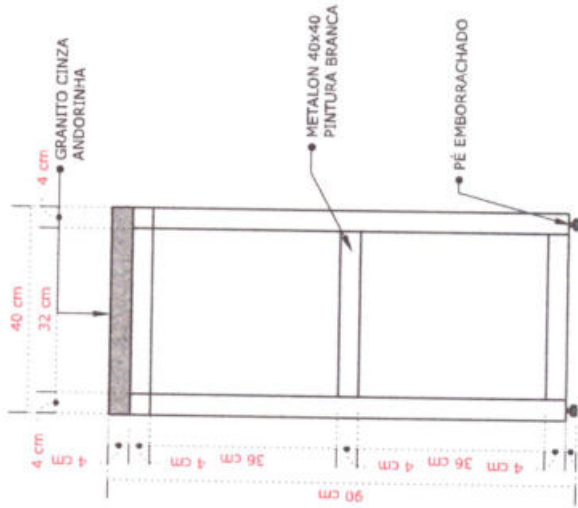

03 - VISTA LATERAL MB26  
ESCALA.....1/10

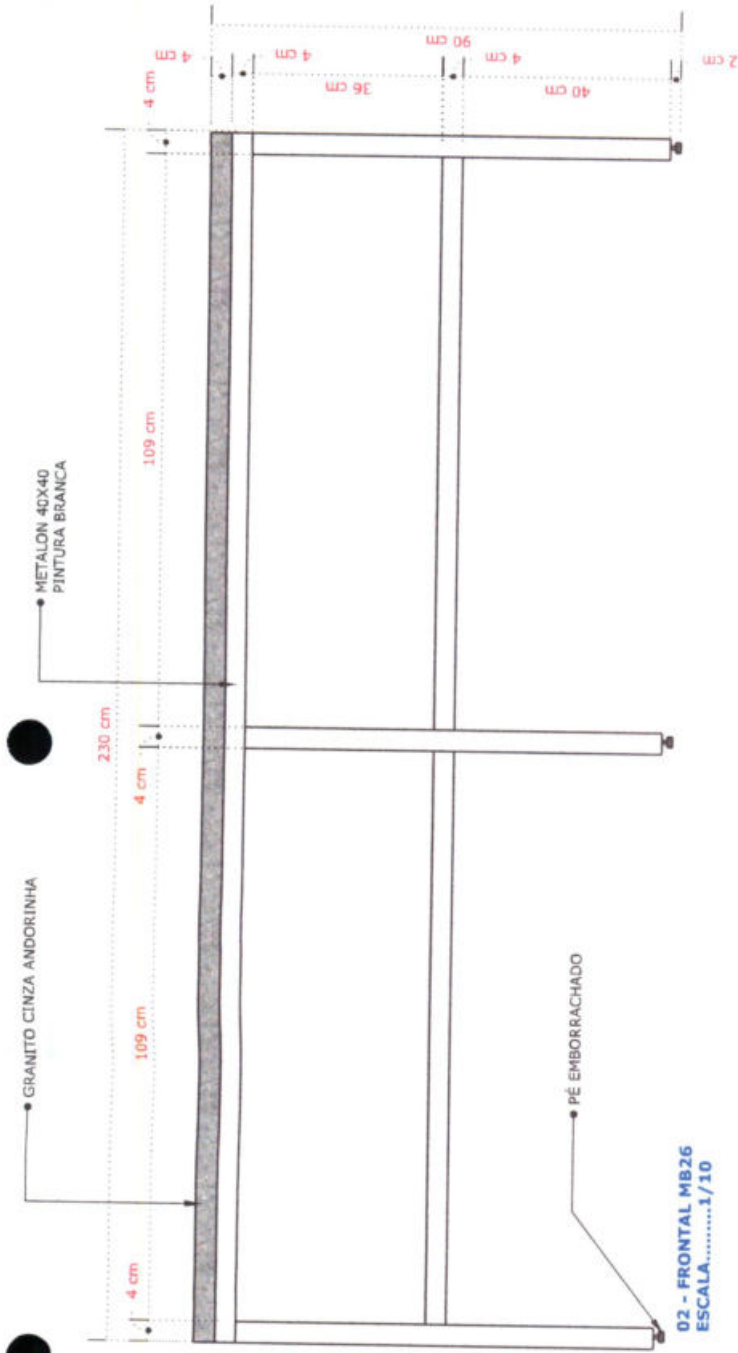

02 - FRONTAL MB26  
ESCALA.....1/10



04 - VISTA SUPERIOR MB26  
ESCALA.....1/10



ATENÇÃO: CONFERIR MEDIDAS DOS AMBIENTES ANTES DE EXECUTAR OS MÓVEIS

**MOBILIÁRIO CENTRO DE IMAGENS DE HORIZONTE**

PROPRIETÁRIO: PREFEITURA MUNICIPAL DE HORIZONTE  
AUTOR DO PROJETO: ARQ. GEFERSON RAFAEL- CAU Nº A261.764-1

**CONTEÚDO:**

- 01- ISOMÉTRICA MB26.....1/20
- 02- VISTA FRONTAL MB26.....1/10
- 03- VISTA LATERAL MB26.....1/10
- 04- VISTA SUPERIOR MB26.....1/10

**PRANCHA:**

**46 / 65**



*(Handwritten signature)*







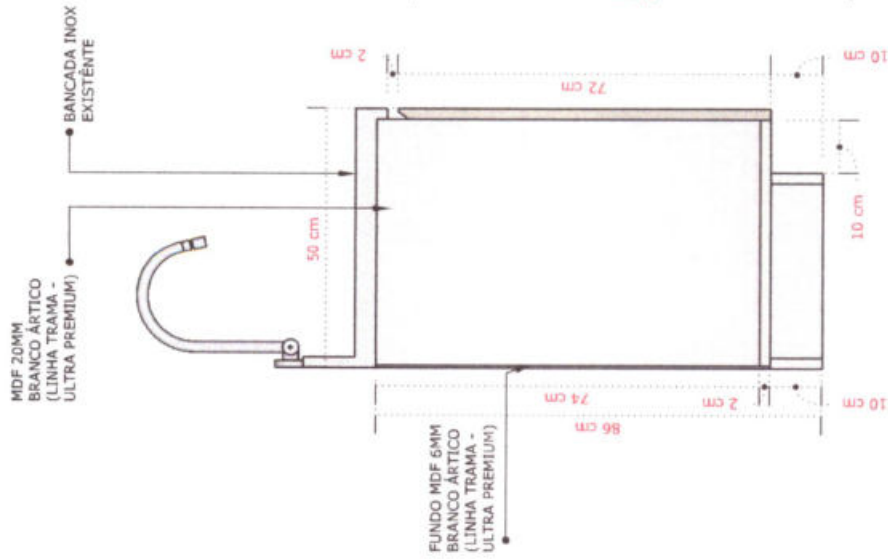

01 - VISTA LATERAL MB27  
ESCALA.....1/10

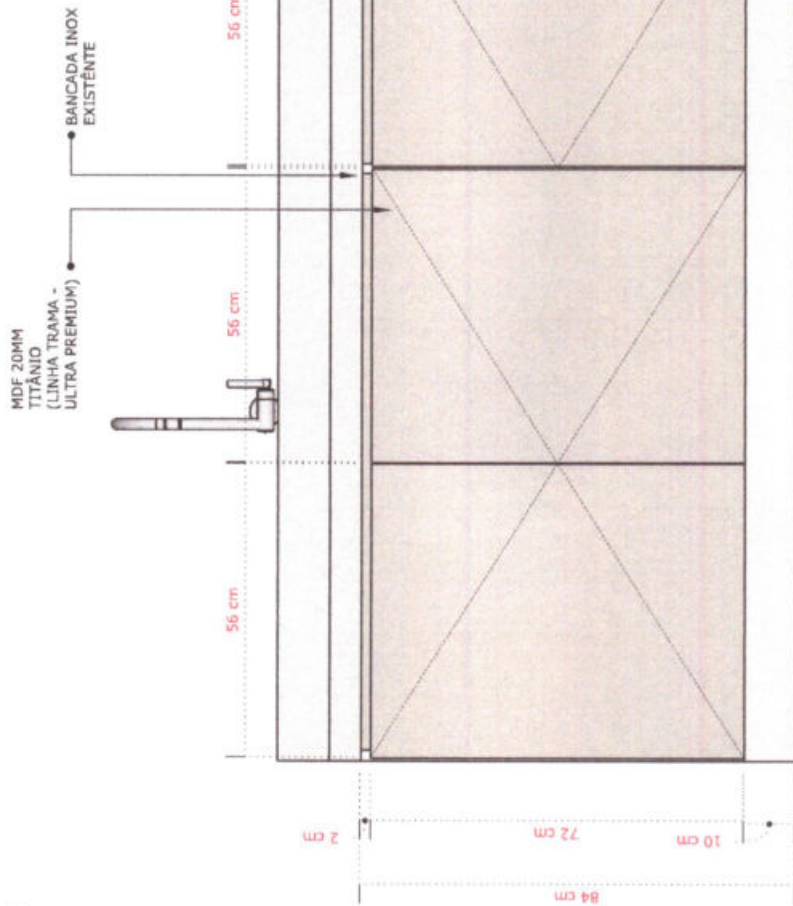

02 - VISTA LATERAL MB27  
ESCALA.....1/10

ATENÇÃO: CONFERIR MEDIDAS DOS AMBIENTES ANTES DE EXECUTAR OS MÓVEIS

**MOBILIÁRIO CENTRO DE IMAGENS DE HORIZONTE**

PROPRIETÁRIO: PREFEITURA MUNICIPAL DE HORIZONTE

LOCAL: HORIZONTE - CE

AUTOR DO PROJETO: ARQ. GEFERSON RAFAEL- CAU Nº A261764-1

DATA: OUTUBRO - 2023

**CONTEÚDO:**

- 01- VISTA LATERAL MB27.....1/10
- 02- VISTA FRONTAL MB27.....1/10

**PRANCHA:**

**48/65**



*[Handwritten signature]*

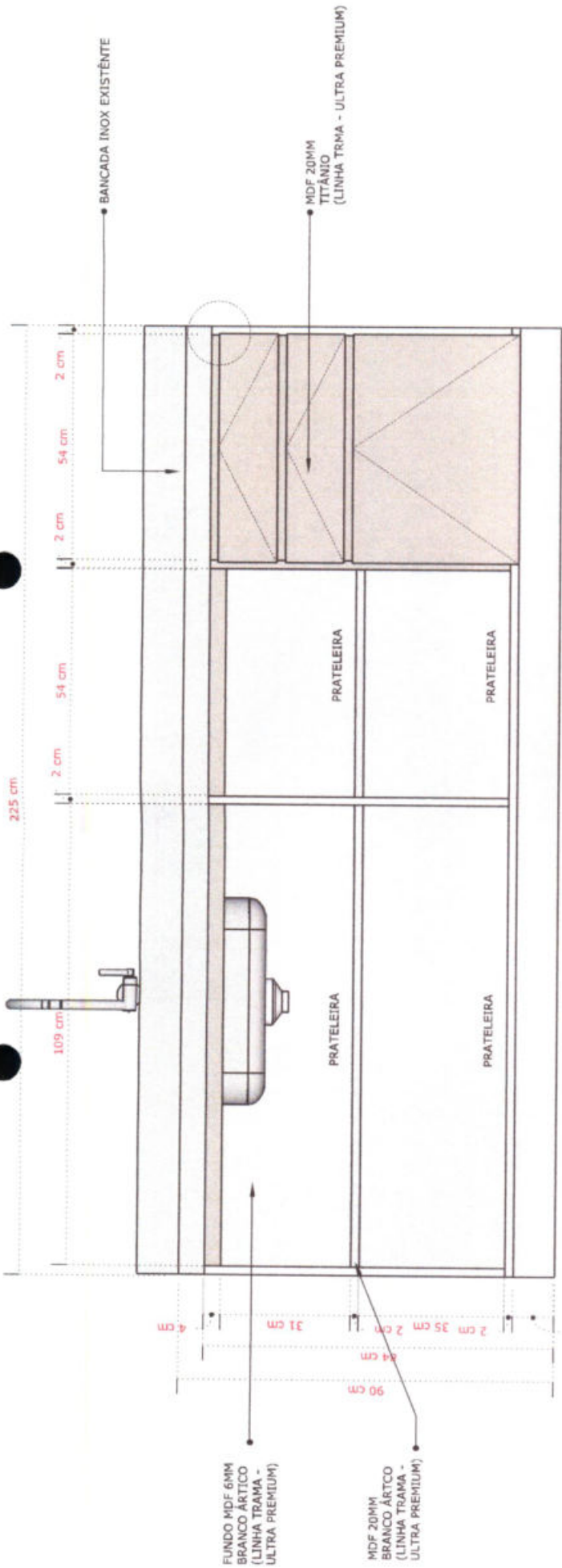

01 - VISTA INTERNA MB27  
ESCALA.....1/10

ESTRUTURA MDF 10MM  
BRANCO ÁRTICO  
(LINHA TRAMA -  
ULTRA PREMIUM)

MDF 20MM  
TITÂNIO  
(LINHA TRAMA -  
ULTRA PREMIUM)

ESRUTURA MDF 10MM  
BRANCO ÁRTICO  
(LINHA TRAMA -  
ULTRA PREMIUM)

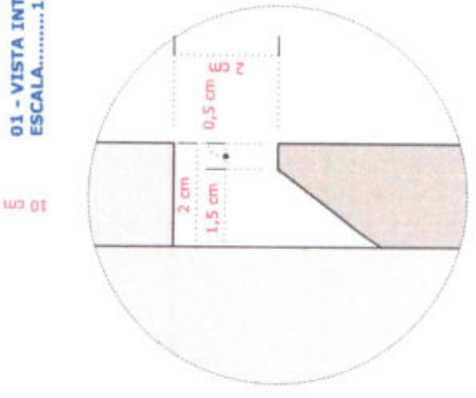
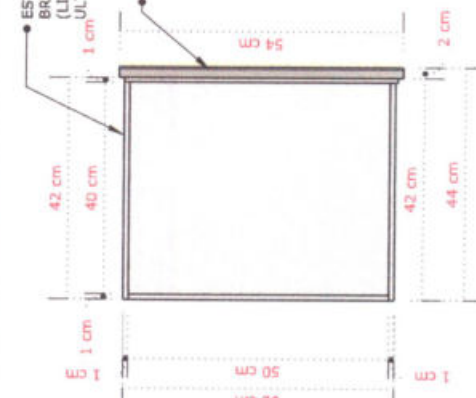
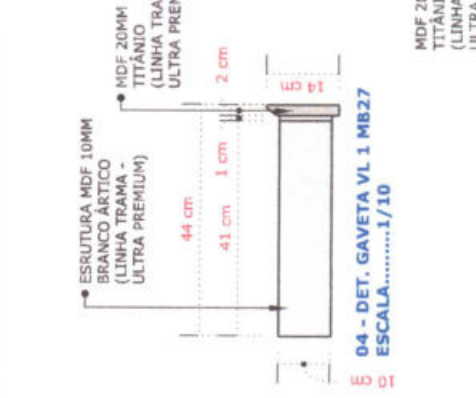

**MOBILIÁRIO CENTRO DE IMAGENS DE HORIZONTE**

PROPRIETÁRIO: PREFEITURA MUNICIPAL DE HORIZONTE  
AUTOR DO PROJETO: ARQ. GEFERSON RAFAEL- CAU Nº A261764-1

LOCAL: HORIZONTE - CE  
DATA: OUTUBRO - 2023

**CONTEÚDO:**

- 01- VISTA INTERNA MB27 .....1/10
- 02- DET. PUXADOR CAVA MB27 .....1/1
- 03- DET. GAVETA VS 1 E 2 MB27 .....1/10
- 04- DET. GAVETA VL 1 MB27 .....1/10
- 05- DET. GAVETA VL 2 MB27 .....1/10

**PRANCHA:**

**49 / 65**



*(Handwritten signature)*

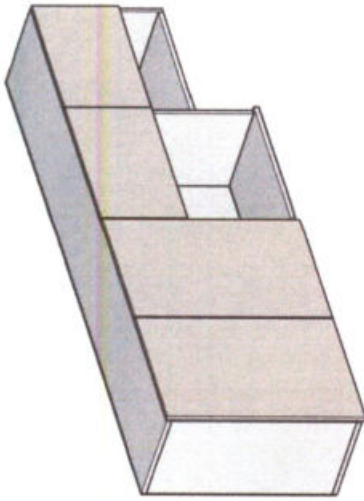

01 - ISOMÉTRICA MB28  
ESCALA.....1/20

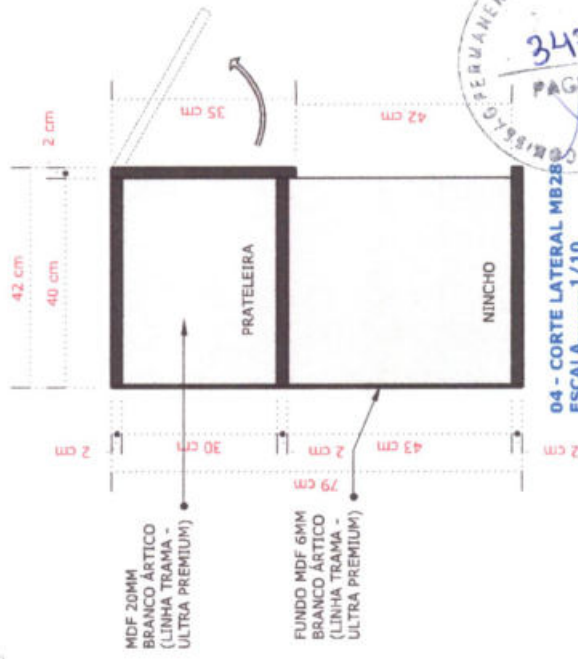
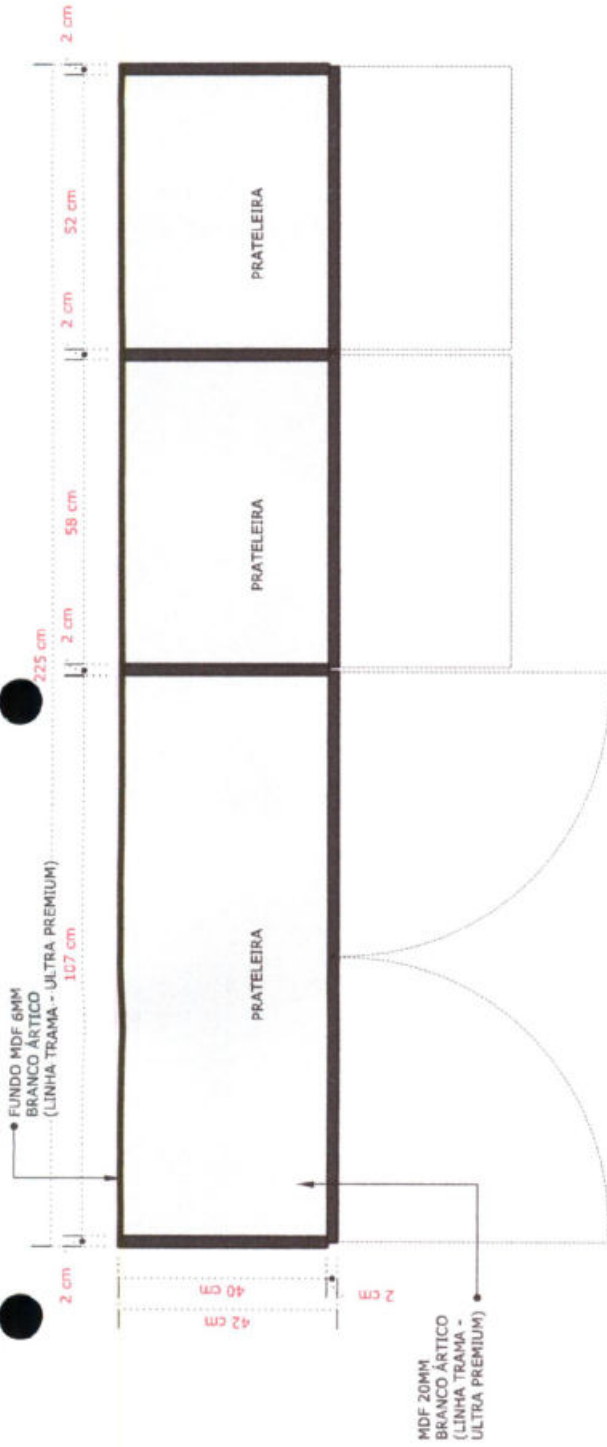

04 - CORTE LATERAL MB28  
ESCALA.....1/10

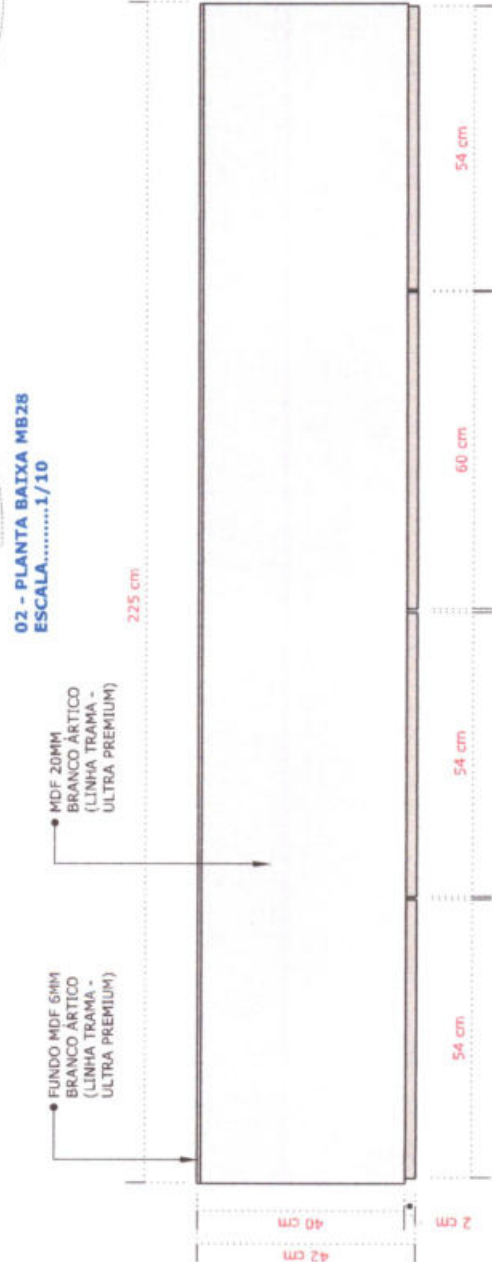

ATENÇÃO: CONFERIR MEDIDAS DOS AMBIENTES ANTES DE EXECUTAR OS MÓVEIS

<b>MOBILIÁRIO CENTRO DE IMAGENS DE HORIZONTE</b>		<b>CONTEÚDO:</b> 01- ISOMÉTRICA MB28.....1/20 02- PLANTA BAIXA MB28.....1/10 03- VISTA SUPERIOR MB28.....1/10 04- CORTE LATERAL MB28.....1/10	<b>PRANCHA:</b> <b>50/65</b>	
<b>PROPRIETÁRIO:</b> PREFEITURA MUNICIPAL DE HORIZONTE	<b>LOCAL:</b> HORIZONTE - CE	<b>DATA:</b> OUTUBRO - 2023	<b>AUTOR DO PROJETO:</b> ARQ. GEFERSON RAFAEL- CAU Nº A261764-1	<b>PREFEITURA DE HORIZONTE</b> DE MÃOS DADAS COM VOCE



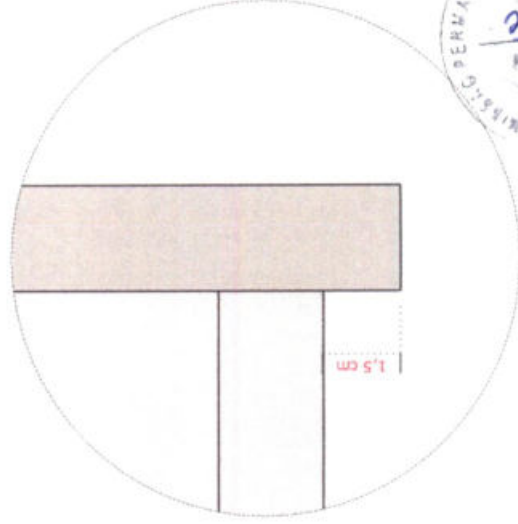
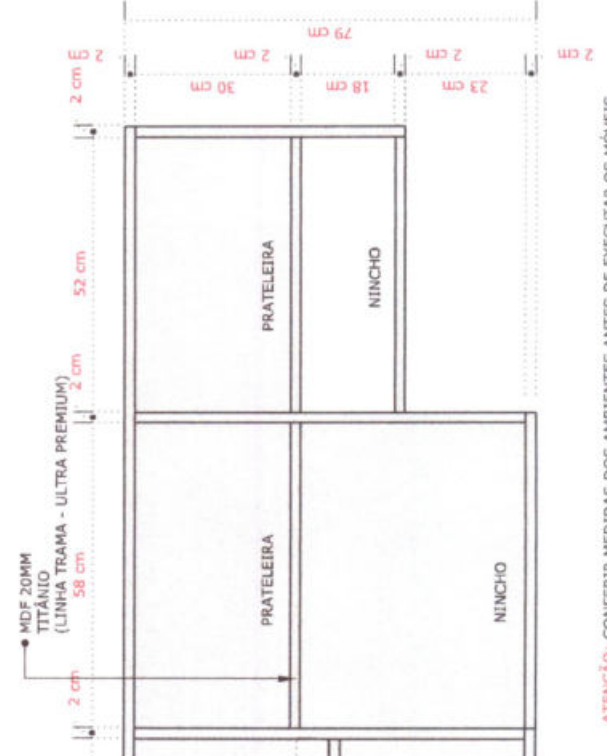
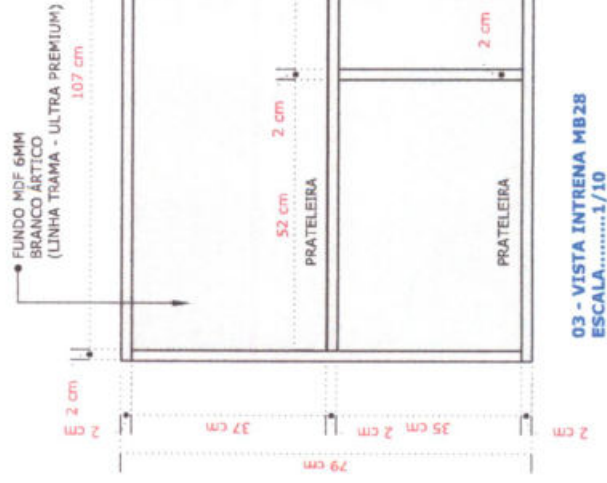
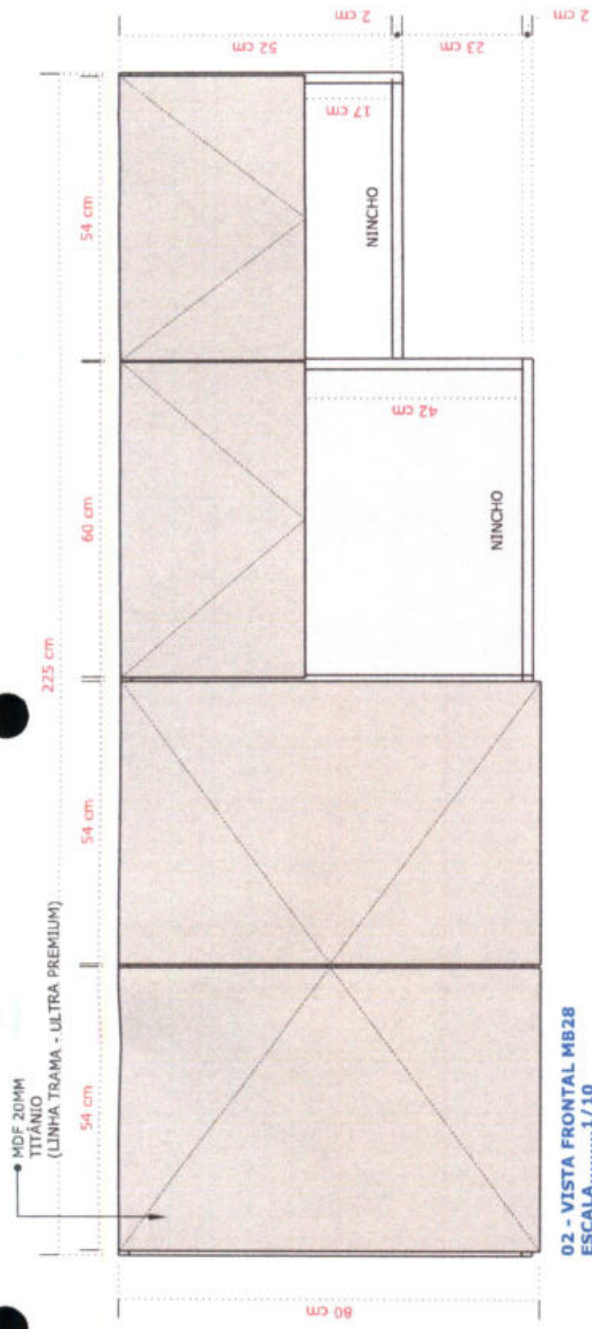
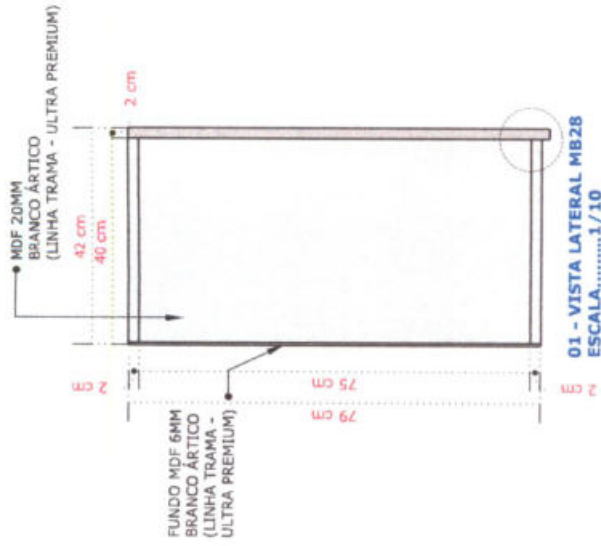

ATENÇÃO: CONFERIR MEDIDAS DOS AMBIENTES ANTES DE EXECUTAR OS MÓVEIS

**MOBILIÁRIO CENTRO DE IMAGENS DE HORIZONTE**

PROPRIETÁRIO: PREFEITURA MUNICIPAL DE HORIZONTE  
AUTOR DO PROJETO: ARQ. GEFERSON RAFAEL- CAU Nº A261764-1

LOCAL: HORIZONTE - CE  
DATA: OUTUBRO - 2023

**CONTEÚDO:**

- 01- VISTA LATERAL MB28.....1/10
- 02- VISTA FRONTAL MB28.....1/10
- 03- VISTA INTERNA MB28.....1/10
- 04- DET. PUXADOR MB28.....1/1

**PRANCHA:**

**51/65**



04 - DET. PUXADOR MB28 MB28  
ESCALA.....1/1

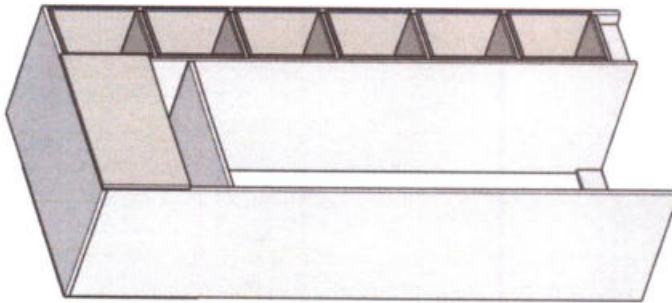

01 - ISOMÉTRICA MB29  
ESCALA.....1/20

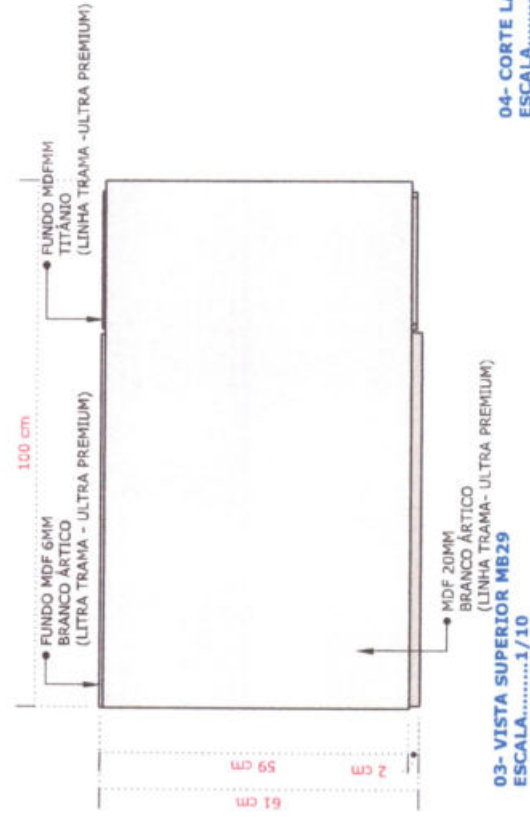
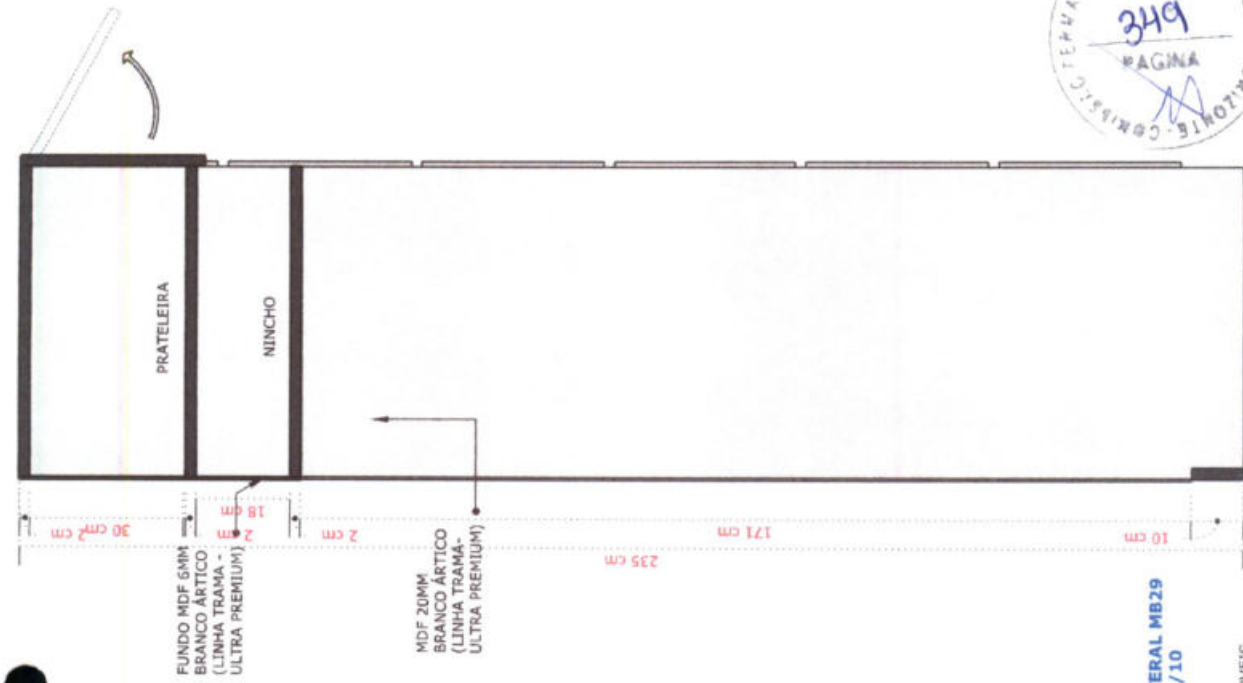
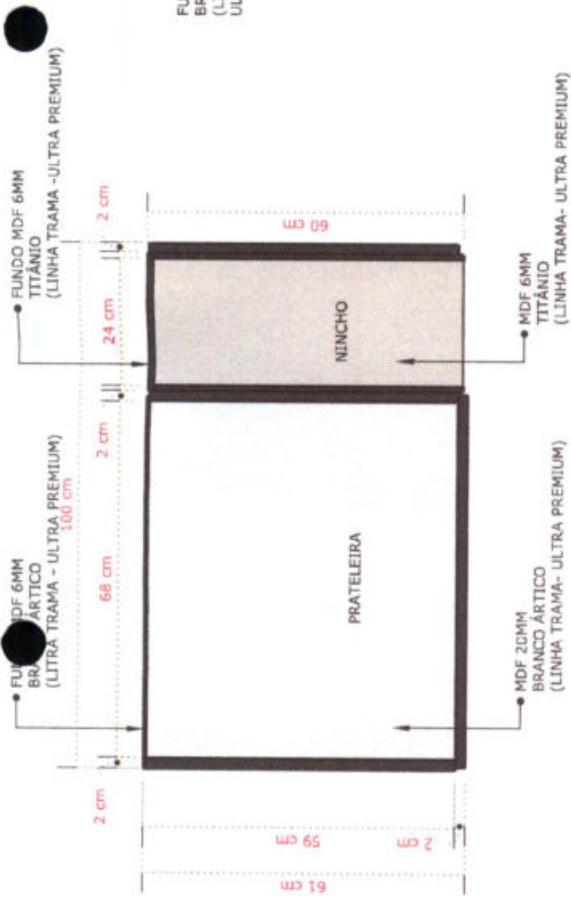

ATENÇÃO: CONFERIR MEDIDAS DOS AMBIENTES ANTES DE EXECUTAR OS MÓVEIS



	<b>PRANCHA:</b> 52 / 65	<b>CONTEÚDO:</b> 01- ISOMÉTRICA MB29.....1/20 02- PLANTA BAIXA MB29.....1/10 03- VISTA SUPERIOR MB29.....1/10 04- CORTE LATERAL MB29.....1/10	<b>MOBILIÁRIO CENTRO DE IMAGENS DE HORIZONTE</b> PROPRIETÁRIO: PREFEITURA MUNICIPAL DE HORIZONTE LOCAL: HORIZONTE - CE AUTOR DO PROJETO: ARQ. GEFERSON RAFAEL- CAU Nº A261764-1 DATA: OUTUBRO - 2023
--	----------------------------	---	--





01 - VISTA LATERAL MB29  
ESCALA.....1/10

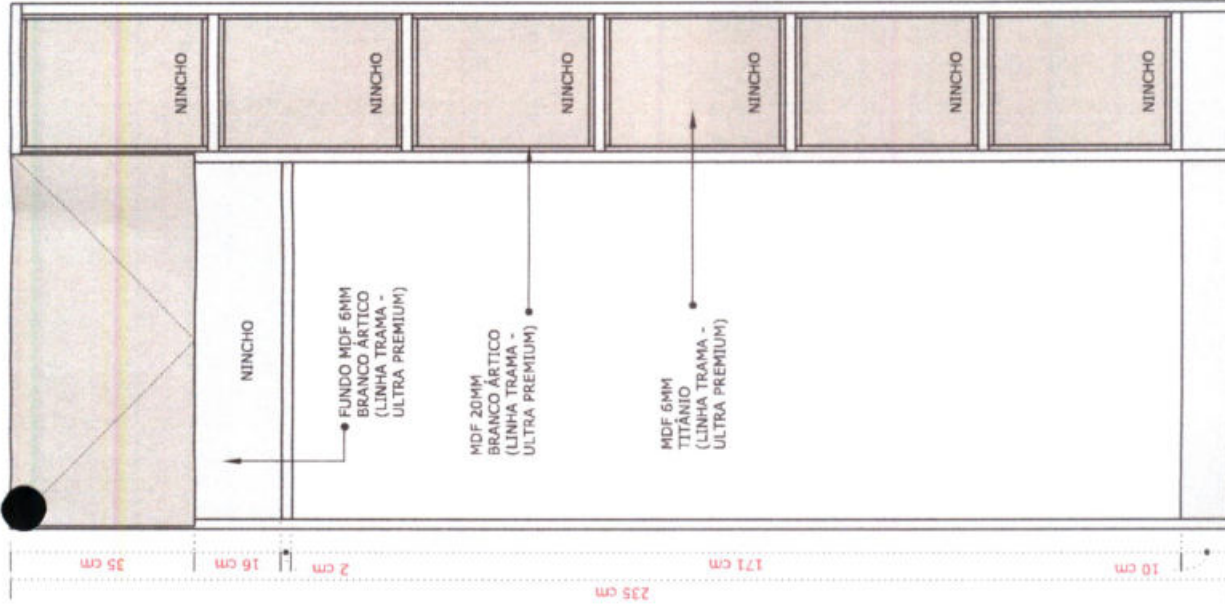

02 - VISTA FRONTAL MB29  
ESCALA.....1/10

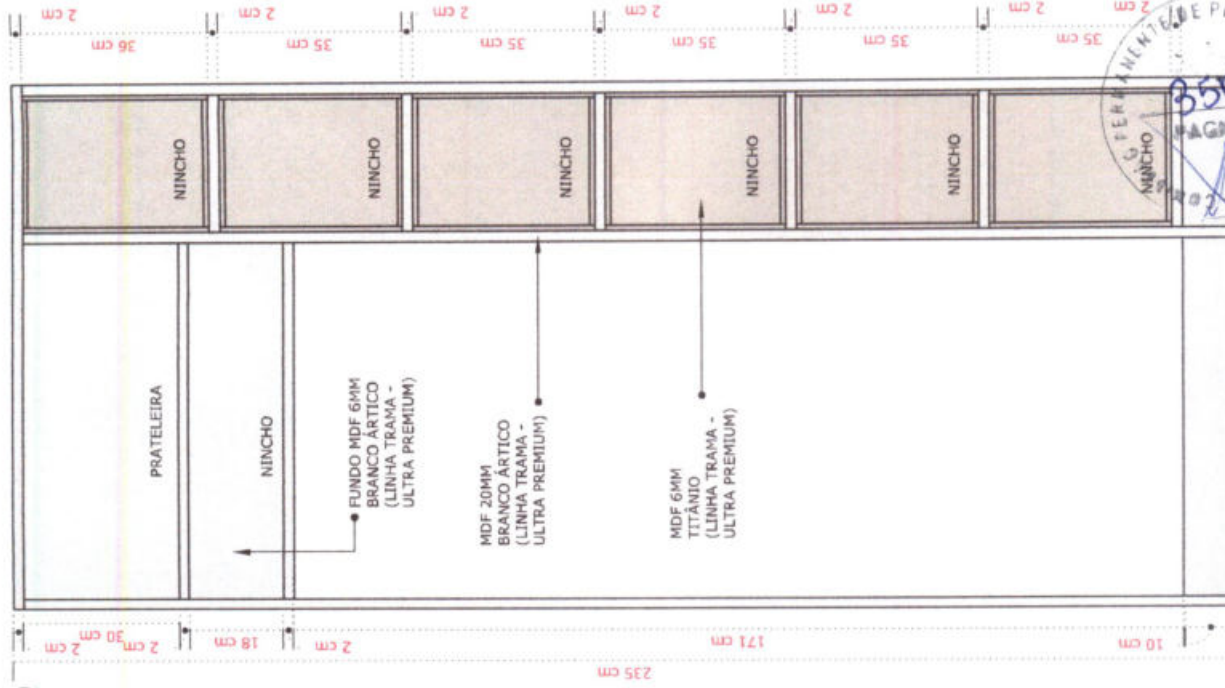

03 - VISTA INTERNA MB29  
ESCALA.....1/10

**MOBILIÁRIO CENTRO DE IMAGENS DE HORIZONTE**

PROPRIETÁRIO: PREFEITURA MUNICIPAL DE HORIZONTE

AUTOR DO PROJETO: ARQ. GEFERSON RAFAEL- CAU Nº A261764-1

LOCAL: HORIZONTE - CE

DATA: OUTUBRO - 2023

**CONTEÚDO:**

- 01- VISTA LATERAL MB29.....1/10
- 02- VISTA FRONTAL MB29.....1/10
- 03- VISTA INTERNA MB29.....1/10

**PRANCHA:**

**53 / 65**





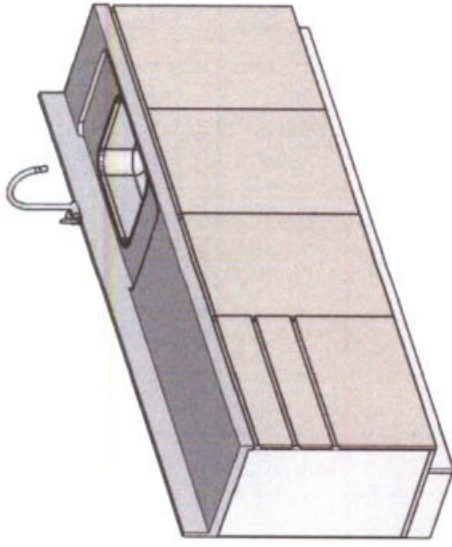

01 - ISOMÉTRICA MB30  
ESCALA.....1/20

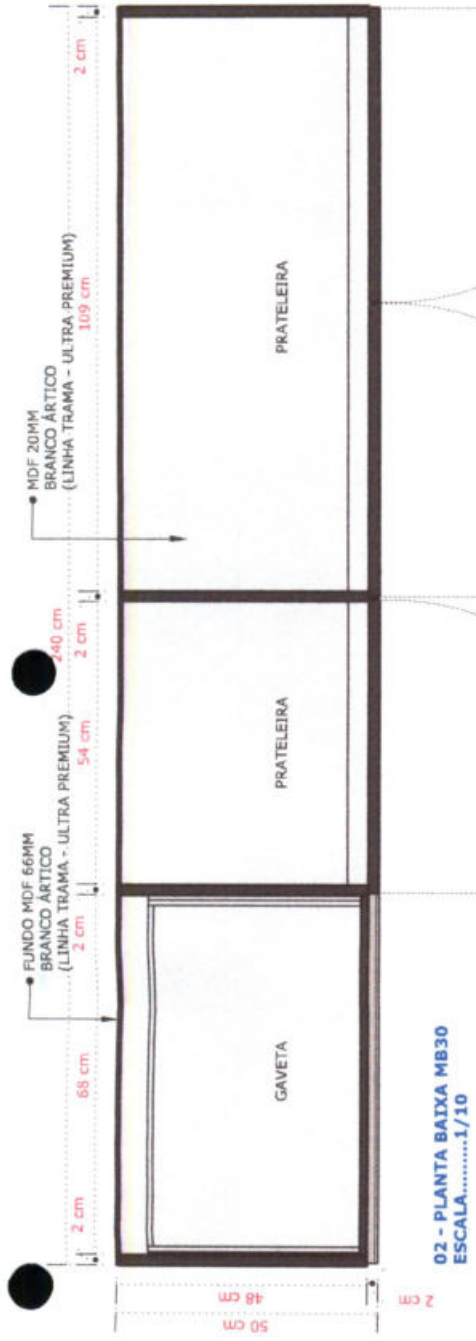

02 - PLANTA BAIXA MB30  
ESCALA.....1/10

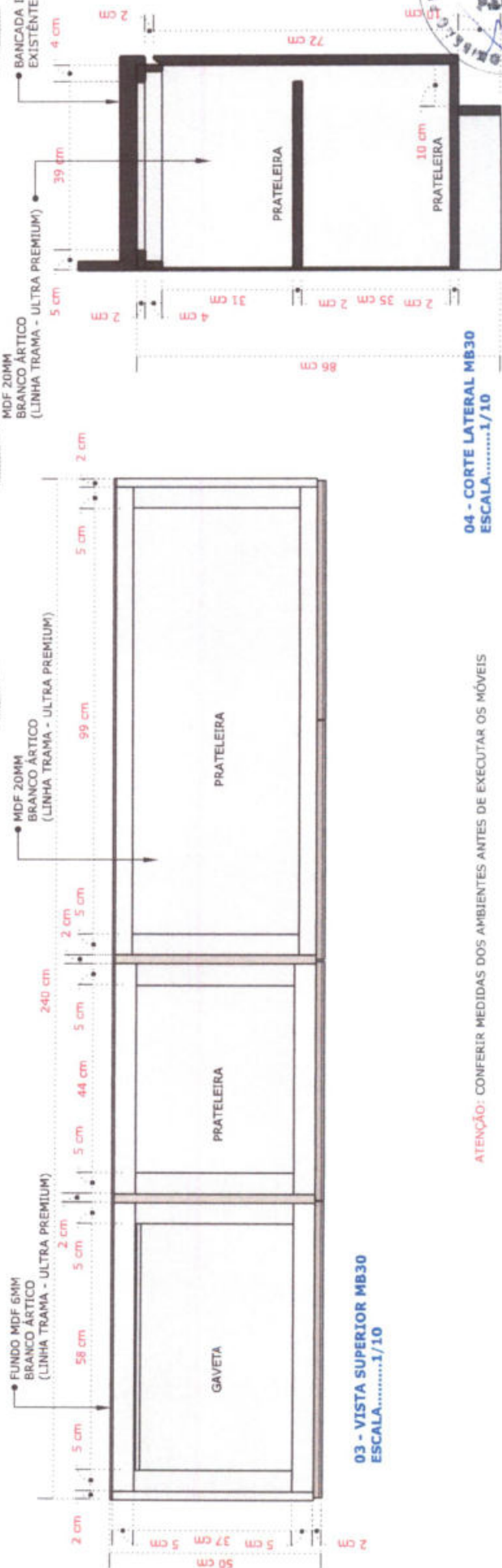

03 - VISTA SUPERIOR MB30  
ESCALA.....1/10

ATENÇÃO: CONFERIR MEDIDAS DOS AMBIENTES ANTES DE EXECUTAR OS MÓVEIS

04 - CORTE LATERAL MB30  
ESCALA.....1/10



**MOBILIÁRIO CENTRO DE IMAGENS DE HORIZONTE**

PROPRIETÁRIO: PREFEITURA MUNICIPAL DE HORIZONTE

AUTOR DO PROJETO: ARQ. GEFERSON RAFAEL- CAU Nº A261764-1

LOCAL: HORIZONTE - CE

DATA: OUTUBRO - 2023

**CONTEÚDO:**

- 01- ISOMÉTRICA MB30.....1/20
- 02- PLANTA BAIXA MB30.....1/10
- 03- VISTA SUPERIOR MB30.....1/10
- 04- CORTE LATERAL MB30.....1/10

**PRANCHA:**

**54/65**



*(Handwritten signature)*

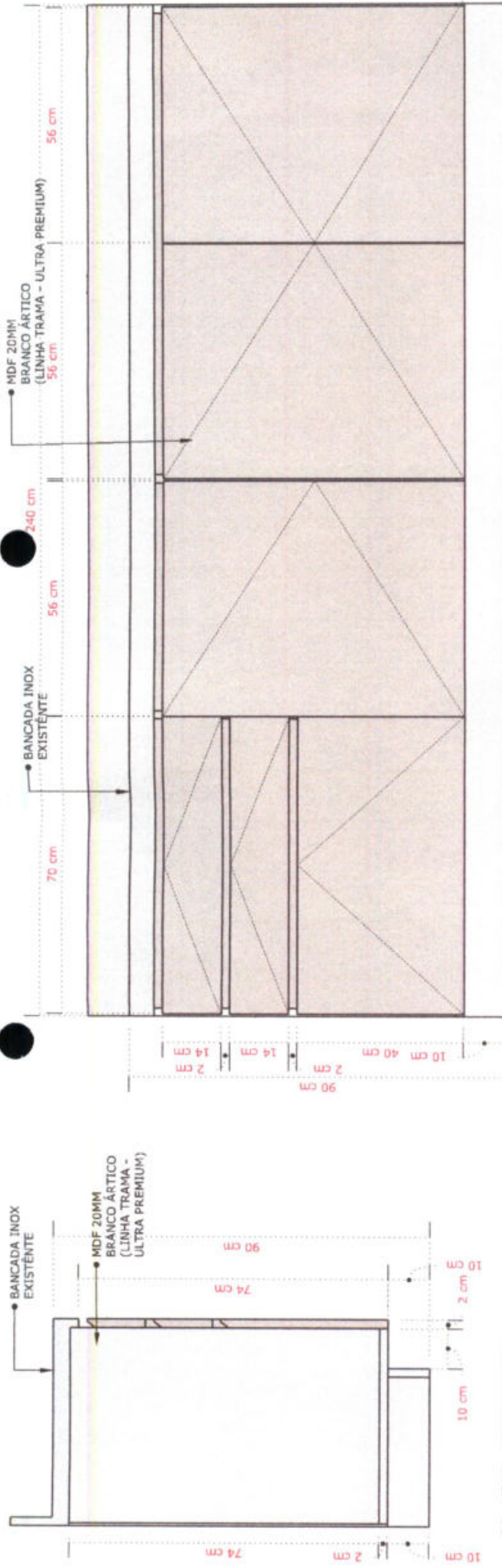

01 - VISTA LATERAL MB30  
ESCALA.....1/10

02 - VISTA FRONTAL MB30  
ESCALA.....1/10

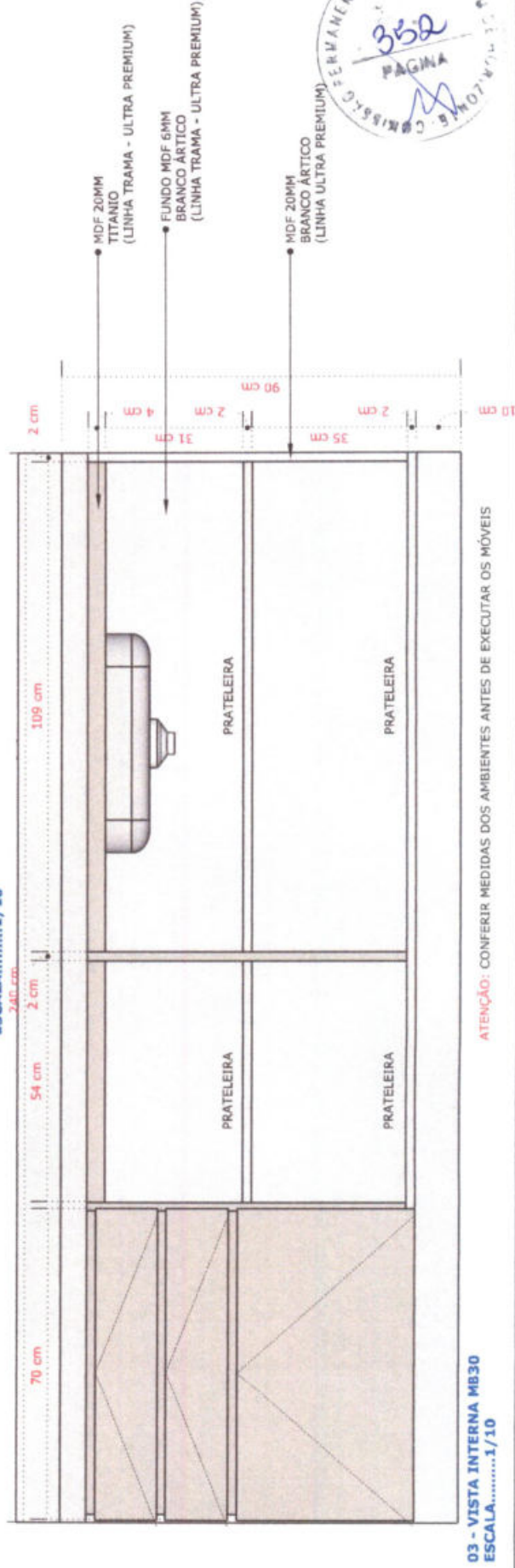

03 - VISTA INTERNA MB30  
ESCALA.....1/10



**MOBILIÁRIO CENTRO DE IMAGENS DE HORIZONTE**

PROPRIETÁRIO: PREFEITURA MUNICIPAL DE HORIZONTE

LOCAL: HORIZONTE - CE

CONTEÚDO:  
01- VISTA LATERAL MB30.....1/10

02- VISTA FRONTAL MB30.....1/10

03- VISTA INTERNA MB30.....1/10

AUTOR DO PROJETO: ARQ. GEFERSON RAFAEL - CAU Nº A261764-1

DATA: OUTUBRO - 2023

PRANCHA:

55/65





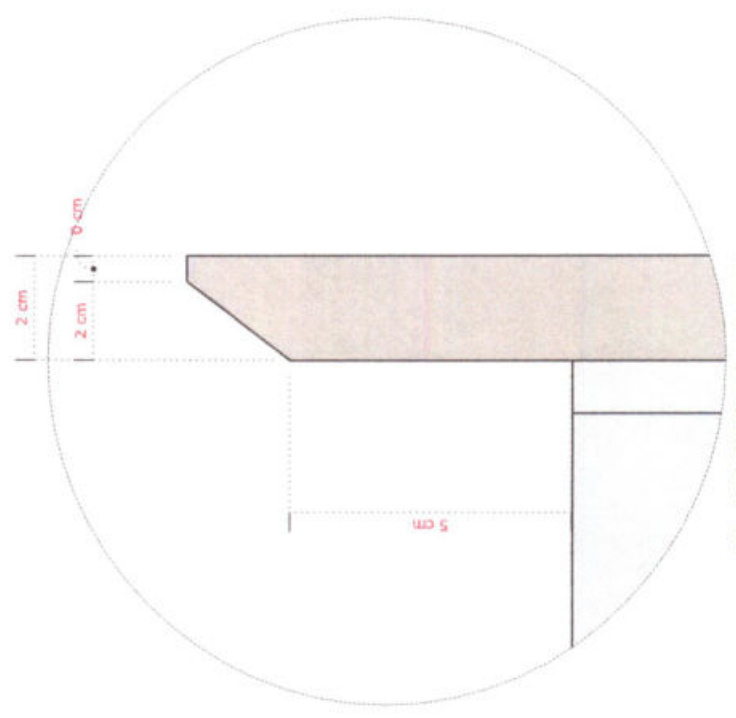
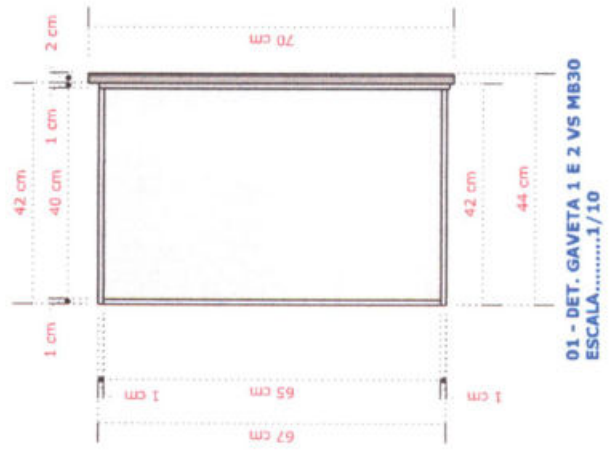
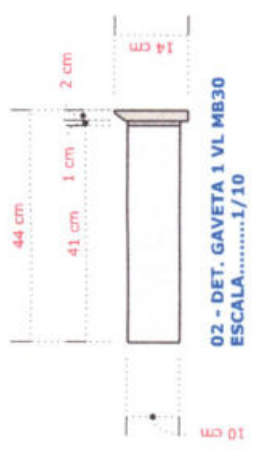
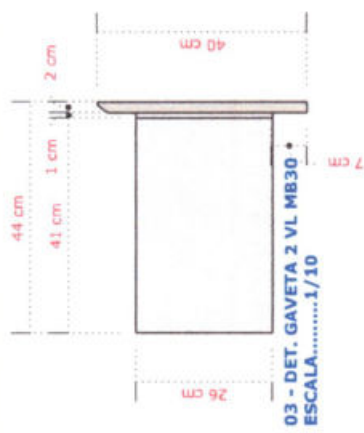

<b>MOBILIÁRIO CENTRO DE IMAGENS DE HORIZONTE</b>	
PROPRIETÁRIO: PREFEITURA MUNICIPAL DE HORIZONTE	LOCAL: HORIZONTE - CE
AUTOR DO PROJETO: ARQ. GEFERSON RAFAEL- CAU Nº A261764-1	DATA: OUTUBRO - 2023
<b>CONTEÚDO:</b>	<b>PRANCHA:</b>
01- DET. GAVETA 1 E 2 VS MB30.....1/10	<b>56/65</b>
02- DET. GAVETA 1 VL MB30.....1/10	
03- DET. GAVETA 2 VL MB30.....1/10	
04- DET. PUXADOR CAVA MB30.....1/1	

*[Handwritten signature]*



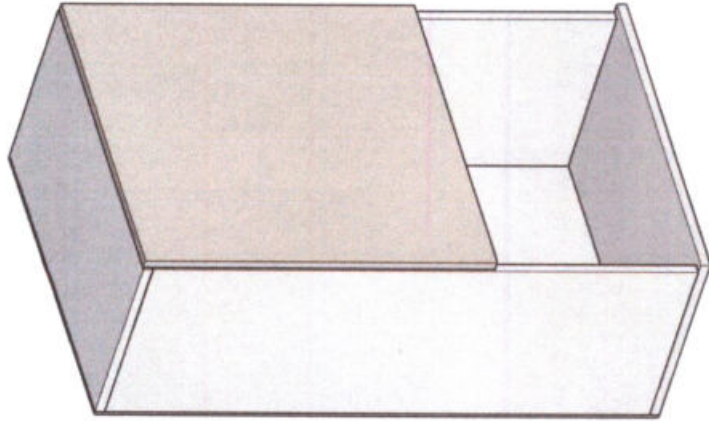

01 - ISOMÉTRICA MB31  
ESCALA.....1/10

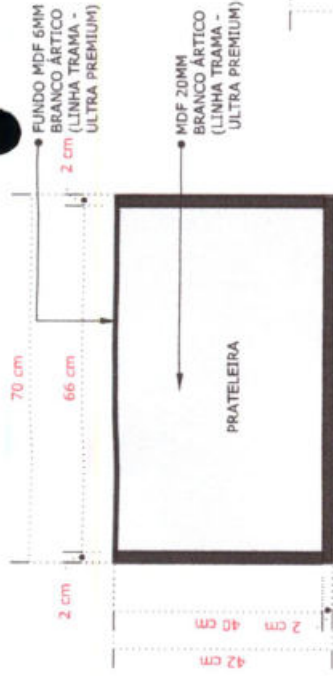

02 - PLANTA BAIXA MB31  
ESCALA.....1/10

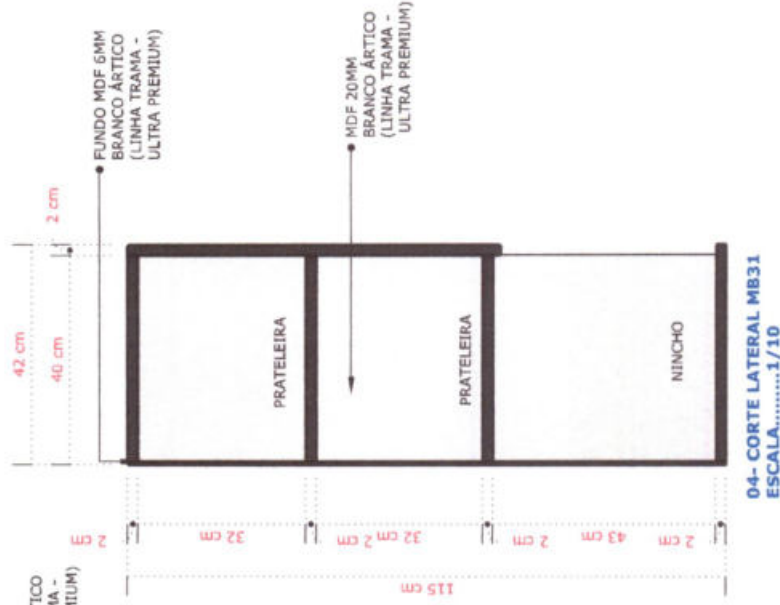

04- CORTE LATERAL MB31  
ESCALA.....1/10

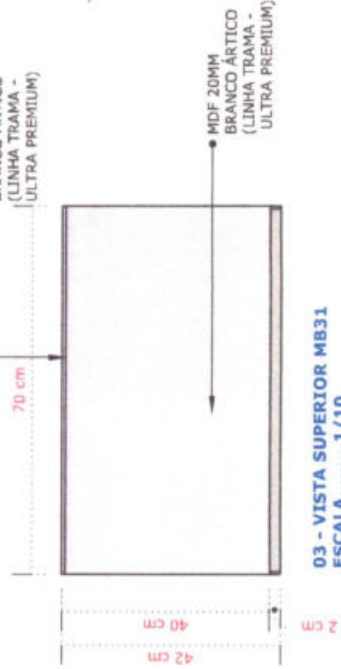

03 - VISTA SUPERIOR MB31  
ESCALA.....1/10



ATENÇÃO: CONFERIR MEDIDAS DOS AMBIENTES ANTES DE EXECUTAR OS MÓVEIS

**MOBILIÁRIO CENTRO DE IMAGENS DE HORIZONTE**

PROPRIETÁRIO: PREFEITURA MUNICIPAL DE HORIZONTE

AUTOR DO PROJETO: ARQ. GEFERSON RAFAEL- CAU Nº A261764-1

LOCAL: HORIZONTE - CE

DATA: OUTUBRO - 2023

**CONTEÚDO:**

- 01- ISOMÉTRICA MB31.....1/10
- 02- PLANTA BAIXA MB31.....1/10
- 03- VISTA SUPERIOR MB31.....1/10
- 04- CORTE LATERAL MB31.....1/10

**PRANCHA:**

57/65



*[Handwritten signature]*

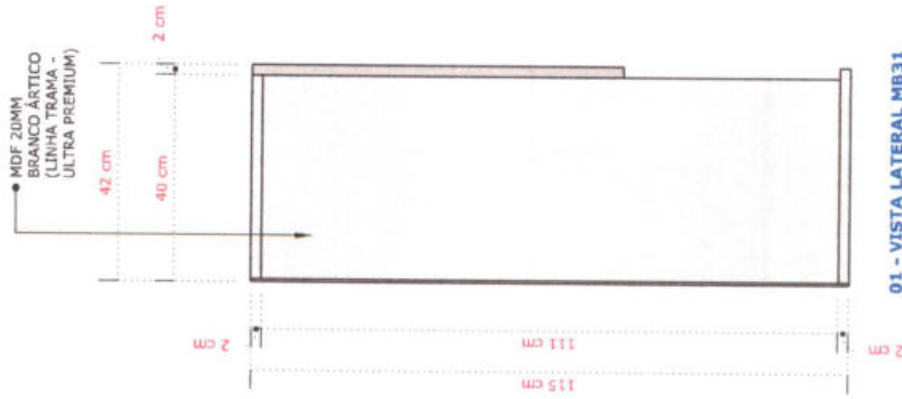

01 - VISTA LATERAL MB31  
ESCALA.....1/10

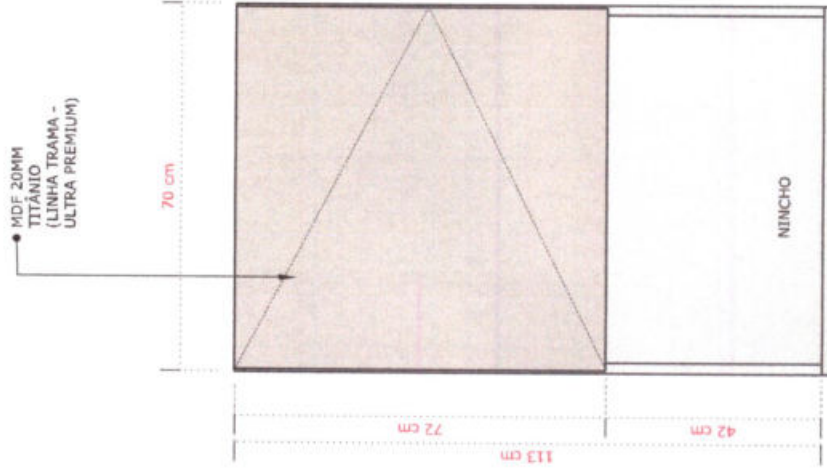

02 - VISTA FRONTAL MB31  
ESCALA.....1/10

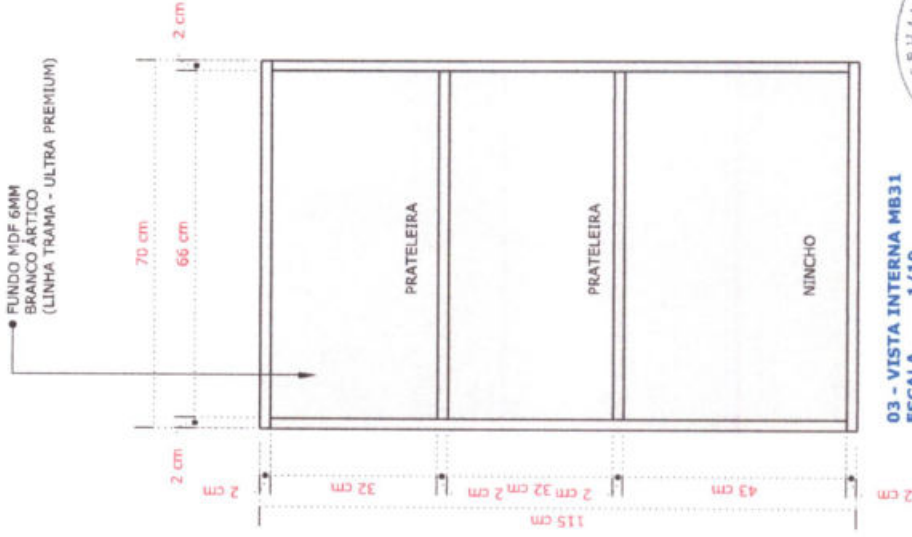

03 - VISTA INTERNA MB31  
ESCALA.....1/10



ATENÇÃO: CONFERIR MEDIDAS DOS AMBIENTES ANTES DE EXECUTAR OS MÓVEIS

### MOBILIÁRIO CENTRO DE IMAGENS DE HORIZONTE

PROPRIETÁRIO: PREFEITURA MUNICIPAL DE HORIZONTE

AUTOR DO PROJETO: ARQ. GEFERSON RAFAEL- CAU Nº A261764-1

### CONTEÚDO:

- 01- VISTA LATERAL MB31.....1/10
- 02- VISTA FRONTAL MB31.....1/10
- 03- VISTA INTERNA MB31.....1/10

### PRANCHA:

58/65



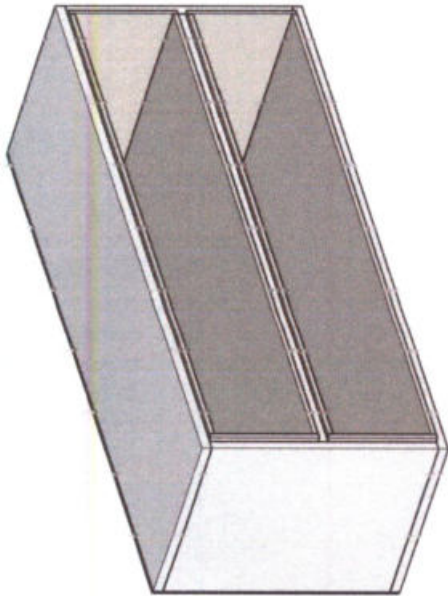

01 - ISOMÉTRICA MB32  
ESCALA.....1/10

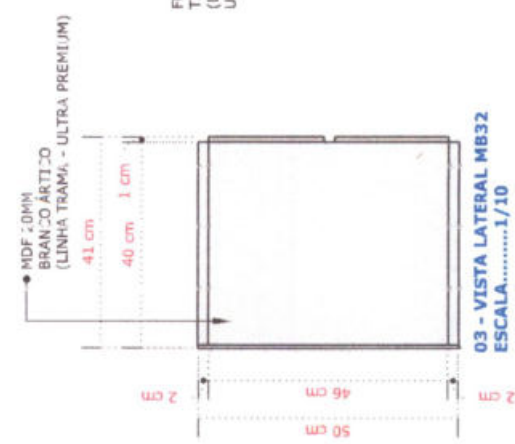

03 - VISTA LATERAL MB32  
ESCALA.....1/10

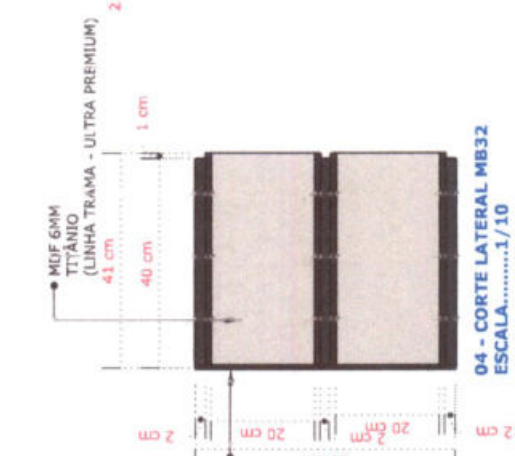

04 - CORTE LATERAL MB32  
ESCALA.....1/10

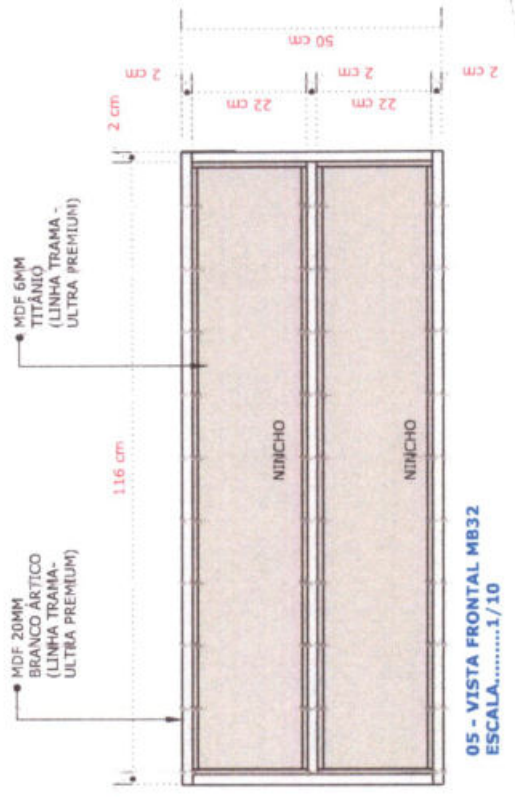

05 - VISTA FRONTAL MB32  
ESCALA.....1/10

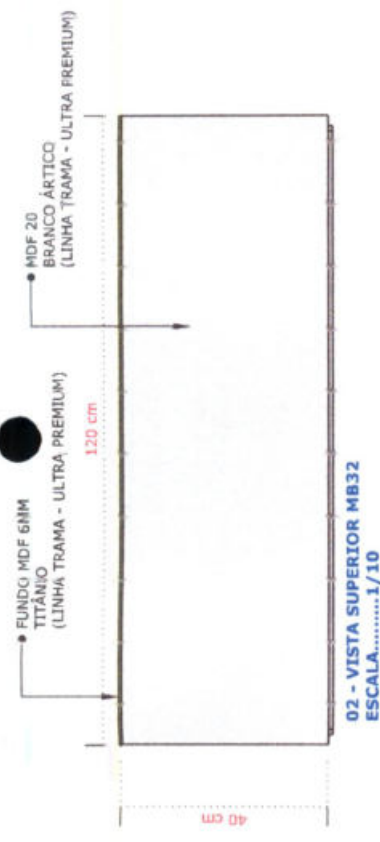

02 - VISTA SUPERIOR MB32  
ESCALA.....1/10

ATENÇÃO: CONFERIR MEDIDAS DOS AMBIENTES ANTES DE EXECUTAR OS MÓVEIS



**MOBILIÁRIO CENTRO DE IMAGENS DE HORIZONTE**

PROPRIETÁRIO: PREFEITURA MUNICIPAL DE HORIZONTE

AUTOR DO PROJETO: ARQ. GEFERSON RAFAEL- CAU Nº A261764-1

LOCAL: HORIZONTE - CE

DATA: OUTUBRO - 2023

**CONTEÚDO:**

- 01- ISOMÉTRICA MB32.....1/10
- 02- VISTA SUPERIOR MB32.....1/10
- 03- VISTA LATERAL MB32.....1/10
- 04- CORTE LATERAL MB32.....1/10
- 05- VISTA FRONTAL MB32.....1/10

PRANCHA:

**59/65**







**FRANCHA:**  
**60/65**

**CONTEÚDO:**

01- ISIOMÉTRICA MB33.....	1/20
02- PLANTA BAIXA MB33.....	1/10
03- VISTA SUPERIOR MB33.....	1/10
04- VISTA FRONTAL MB33.....	1/20
05- VISTA INTERNA MB33.....	1/20
06- CORTE LATERAL MB33.....	1/20
07- VISTA LATERAL MB33.....	1/20

**MOBILIÁRIO CENTRO DE IMAGENS DE HORIZONTE**

PROPRIETÁRIO: PREFEITURA MUNICIPAL DE HORIZONTE

AUTOR DO PROJETO: ARQ. GEFERSON RAFAEL - CAU Nº A26.1764-1

LOCAL: HORIZONTE - CE

DATA: OUTUBRO - 2023

ATENÇÃO: CONFERIR MEDIDAS DOS AMBIENTES ANTES DE EXECUTAR OS MÓVEIS

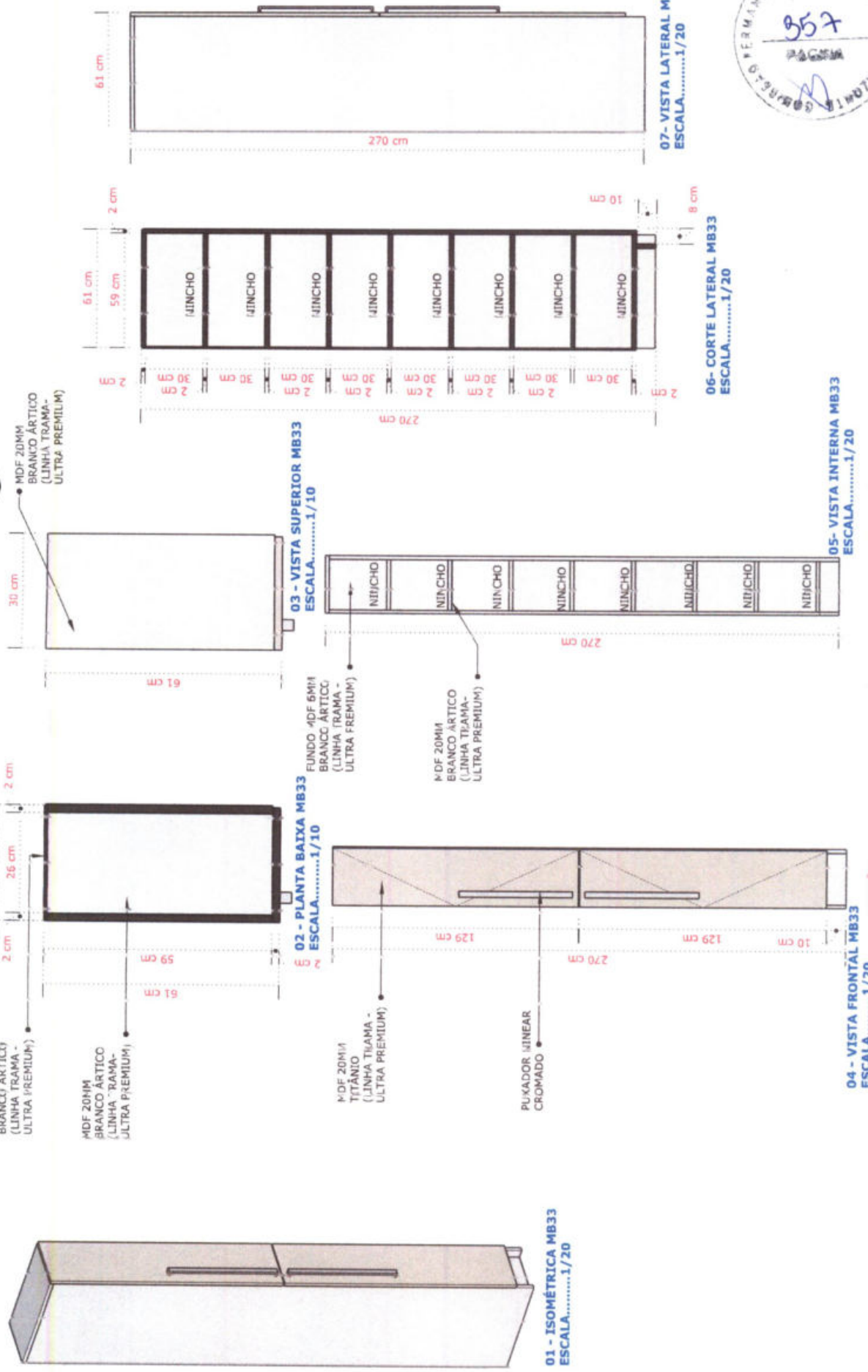

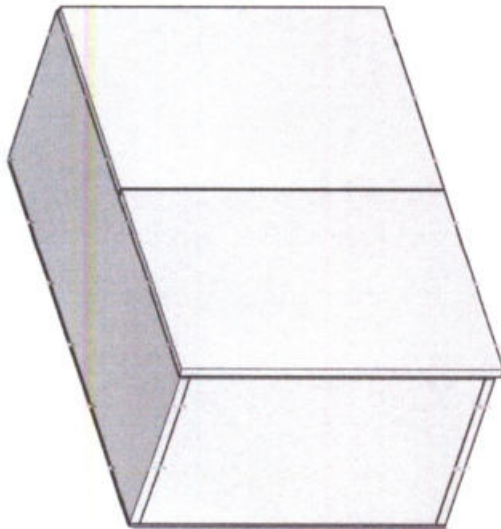

01 - ISOMÉTRICA MB34  
ESCALA.....1/10

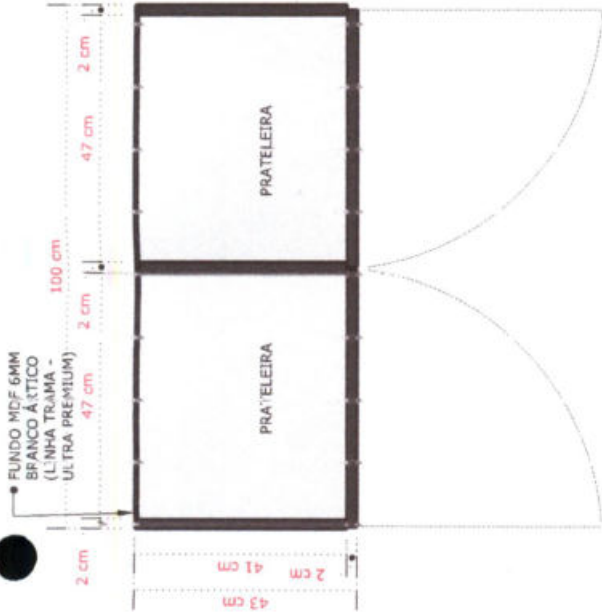

02 - PLANTA BAIXA MB34  
ESCALA.....1/10

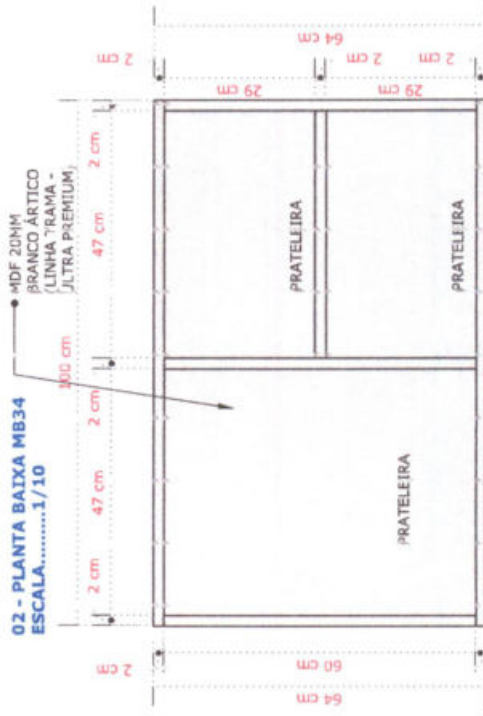

05 - VISTA INTERNA MB34  
ESCALA.....1/10

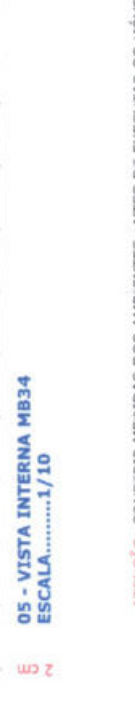

03 - VISTA SUPERIOR MB34  
ESCALA.....1/10

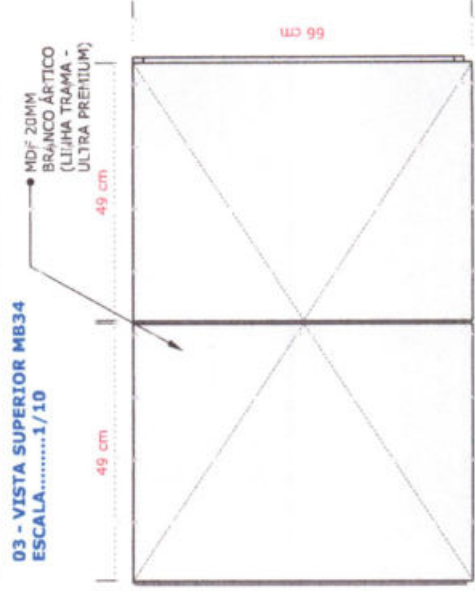

06 - VISTA FRONTAL MB34  
ESCALA.....1/10

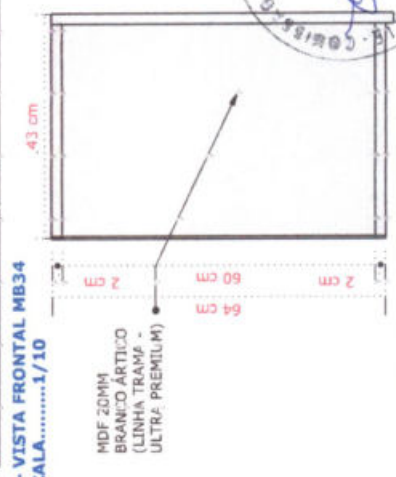

04 - CORTE LATERAL MB34  
ESCALA.....1/10

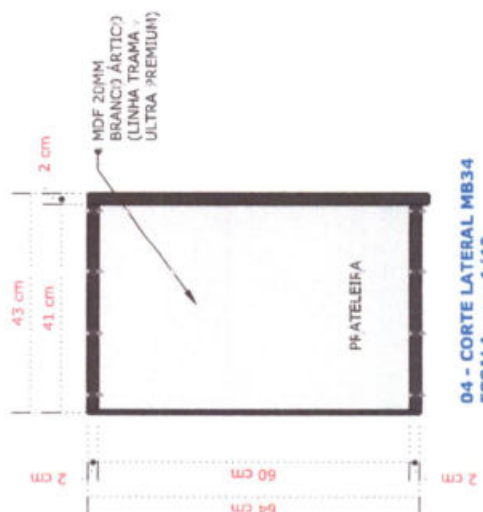

ATENÇÃO: CONFERIR MEDIDAS DOS AMBIENTES ANTES DE EXECUTAR OS MÓVEIS

07 - VISTA LATERAL MB34  
ESCALA.....1/10



**MOBILIÁRIO CENTRO DE IMAGENS DE HORIZONTE**

PROPRIETÁRIO: PREFEITURA MUNICIPAL DE HORIZONTE

AUTOR DO PROJETO: ARQ. GEFERSON RAFAEL- CAU Nº A261.764-1

LOCAL: HORIZONTE - CE

DATA: OUTUBRO - 2023

- CONTEÚDO:**
- 01- ISOMÉTRICA M34.....1/10
  - 02- PLANTA BAIXA MB34.....1/10
  - 03- VISTA SUPERIOR MB34.....1/10
  - 04- CORTE LATERAL MB34.....1/10
  - 05- VISTA INTERNA MB34.....1/10
  - 06- VISTA FRONTAL MB34.....1/10
  - 07- VISTA LATERAL MB34.....1/10

FRANCHA:

**61/65**



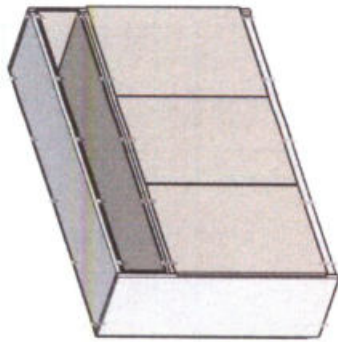

01 - ISOMÉTRICA MB35  
ESCALA.....1/20

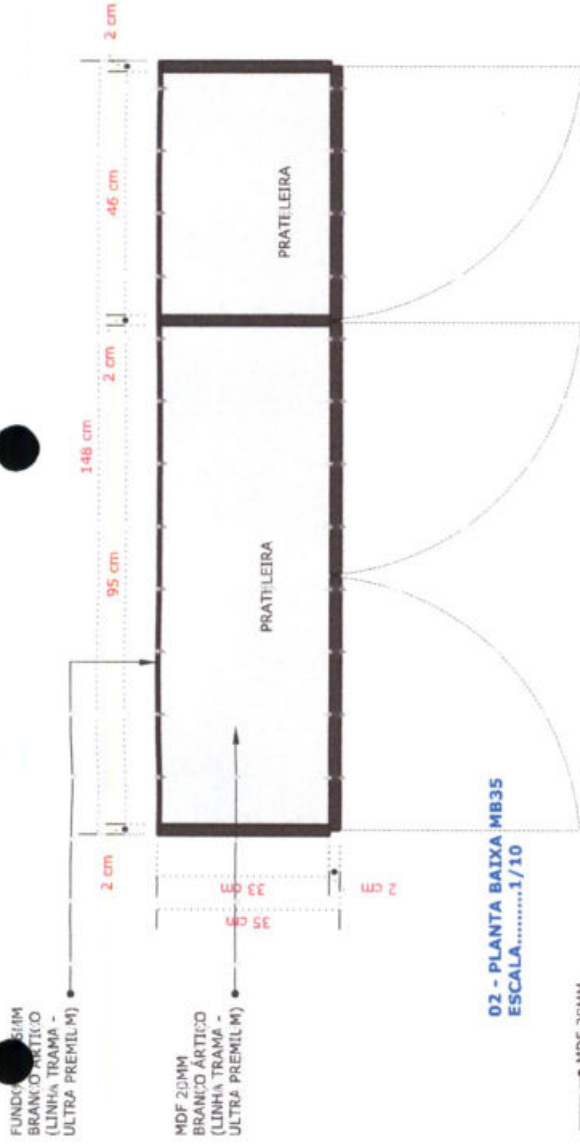

02 - PLANTA BAIXA MB35  
ESCALA.....1/10

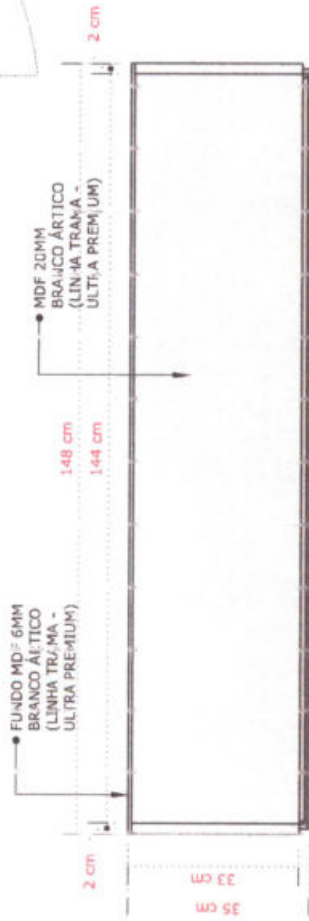

03 - VISTA SUPERIOR MB35  
ESCALA.....1/10

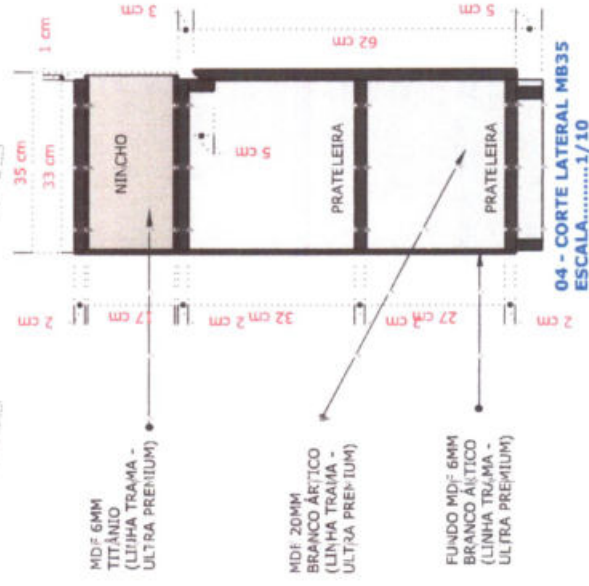

ATENÇÃO: CONFERIR MEDIDAS DOS AMBIENTES ANTES DE EXECUTAR OS MÓVEIS

**MOBILIÁRIO CENTRO DE IMAGENS DE HORIZONTE**

PROPRIETÁRIO: PREFEITURA MUNICIPAL DE HORIZONTE

AUTOR DO PROJETO: ARQ. GEFERSON RAFAEL - CAU Nº A261.764-1

LOCAL: HORIZONTE - CE

DATA: OUTUBRO - 2023

**CONTEÚDO:**

- 01- ISOMÉTRICA MB35.....1/20
- 02- PLANTA BAIXA MB35.....1/10
- 03- VISTA SUPERIOR MB35.....1/10
- 04- CORTE LATERAL MB35.....1/10

FRANCHA:

**62/65**





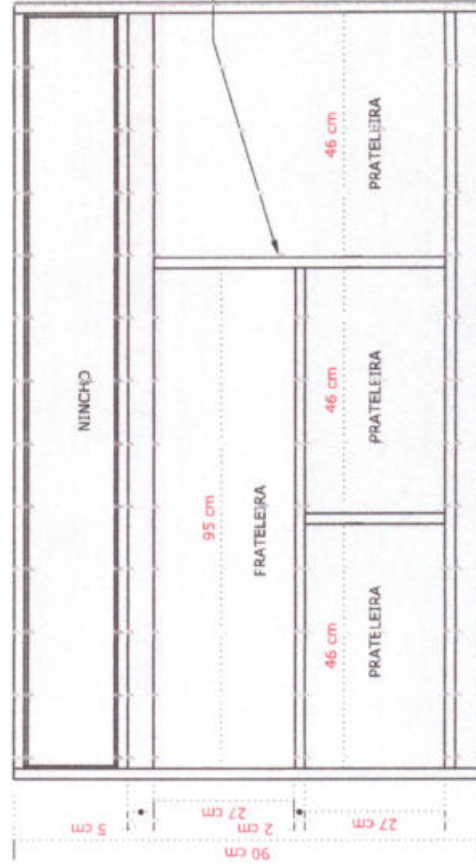
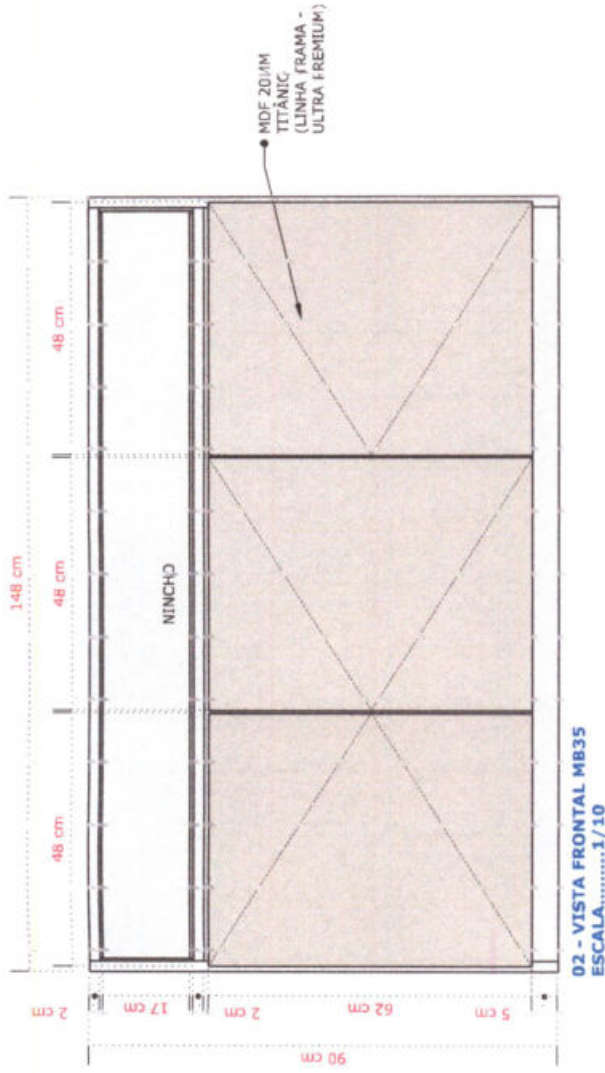
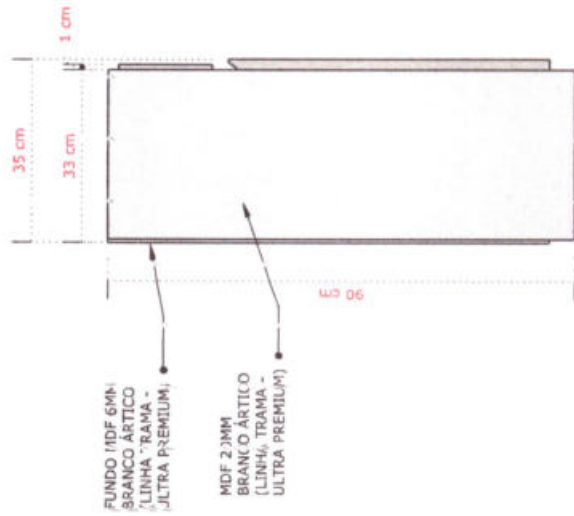

01 - VISTA LATEAL MB35  
ESCALA.....1/10

02 - VISTA FRONTAL MB35  
ESCALA.....1/10

01 - VISTA INTERNA MB35  
ESCALA.....1/10

ATENÇÃO: CONFERIR MEDIDAS DOS AMBIENTES ANTES DE EXECUTAR OS MÓVEIS

**MOBILIÁRIO CENTRO DE IMAGENS DE HORIZONTE**

PROPRIETÁRIO: PREFEITURA MUNICIPAL DE HORIZONTE

AUTOR DO PROJETO: ARQ. GEFERSON RAFAEL - CAU Nº A261.764-1

LOCAL: HORIZONTE - CE

DATA: OUTUBRO - 2023

**CONTÉÚDO:**

- 01- VISTA LATERAL MB35, .....1/10
- 02- VISTA FRONTAL MB35, .....1/10
- 03- VISTA INTERNA MB35, .....1/10

FRANCHA:

**63/65**



*(Handwritten mark)*

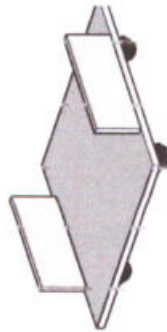

01 - ISOMETRICA MB 36  
ESCALA.....1/10

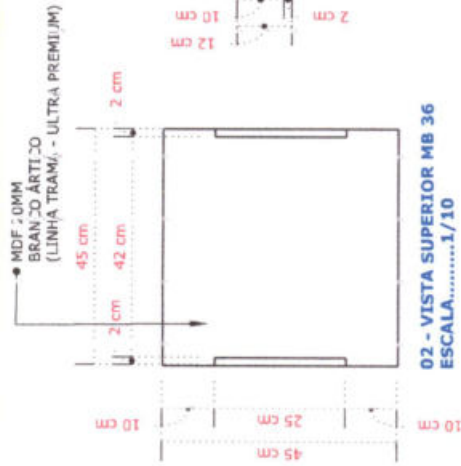

02 - VISTA SUPERIOR MB 36  
ESCALA.....1/10

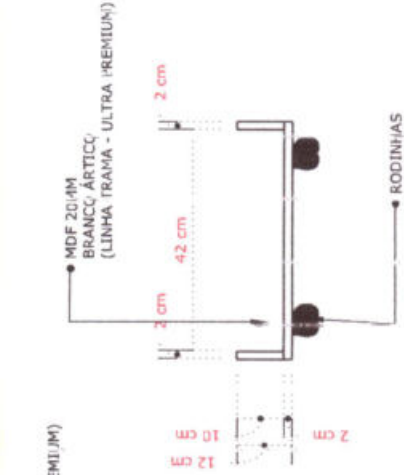

03 - VISTA FRONTAL MB 36  
ESCALA.....1/10

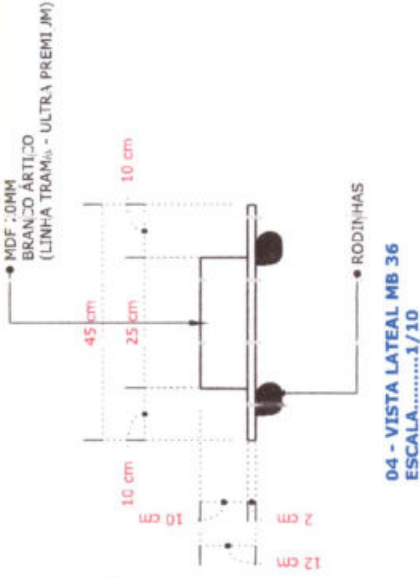

04 - VISTA LATEAL MB 36  
ESCALA.....1/10



**MOBILIÁRIO CENTRO DE IMAGENS DE HORIZONTE**

PROPRIETÁRIO: PREFEITURA MUNICIPAL DE HORIZONTE

AUTOR DO PROJETO: ARQ. GEFERSON RAFAEL- CAU Nº A26.764-1

LOCAL: HORIZONTE - CE

DATA: OUTUBRO - 2023

**CONTEÚDO:**

- 01- ISOMETRICA MB36.....1/10
- 02- VISTA SUPERIOR MB36.....1/10
- 03- VISTA FRONTAL MB36.....1/10
- 04- VISTA LATERAL MB36.....1/10

FRANCHA:

**64/65**



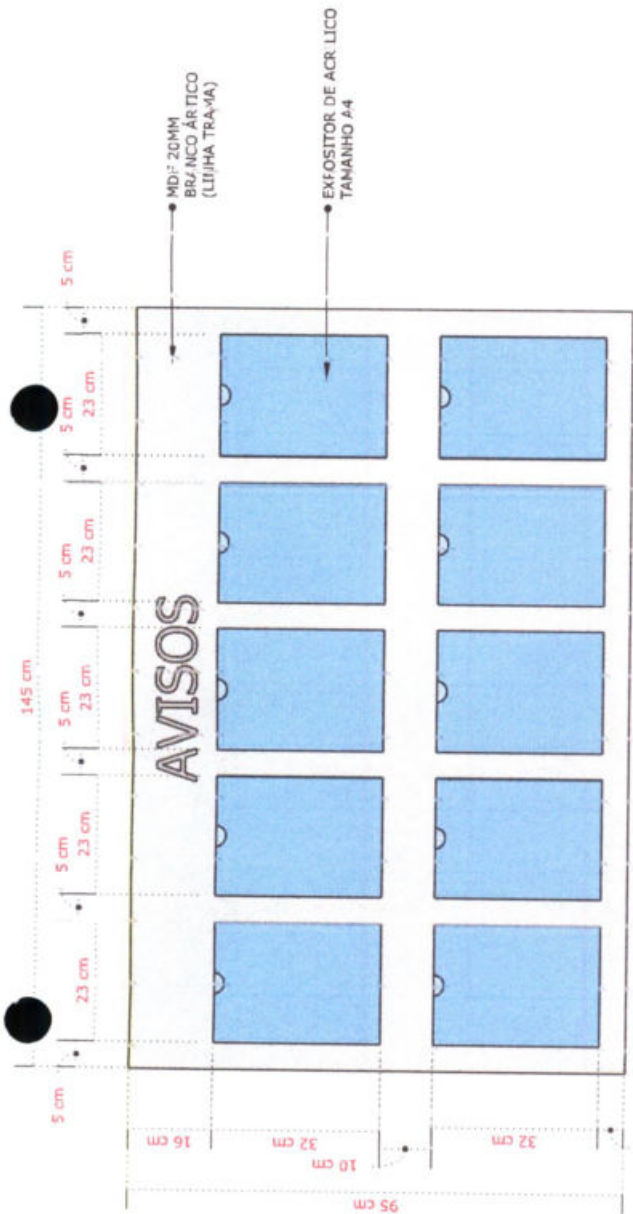

01 - QUADRO DE AVISOS  
ESCALA.....1/10

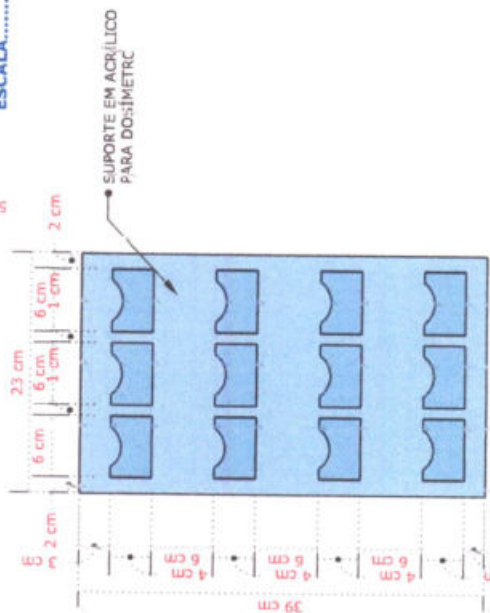

02 - SUPORTE PARA DOSIMETRO  
ESCALA.....1/5

ATENÇÃO: CONFIRAR MEDIDAS DOS AMBIENTES ANTES DE EXECUTAR OS MÓVEIS



FRANCHA:  
65/65

CONTÉÚDO:

- 01- QUADRO DE AVISOS .....1/10
- 02- SUPORTE PARA DOSIMETRO.....1/5

**MOBILIÁRIO CENTRO DE IMAGENS DE HORIZONTE**

PROPRIETÁRIO: PREFEITURA MUNICIPAL DE HORIZONTE

AUTOR DO PROJETO: ARQ. GEFERSON RAFAEL- CAU Nº A261.764-1

LOCAL: HORIZONTE - CE

DATA: OUTUBRO - 2023

*(Handwritten signature)*